

# Rose Door Handles



We take the worry out of  
protecting what's valuable to you.  
Lockwood: *no worries*<sup>®</sup>

**LOCKWOOD**

**ASSA ABLOY**

**25YEAR**

**MECHANICAL  
WARRANTY**

[www.lockweb.com.au](http://www.lockweb.com.au)

# Contents



## Robert Watson Series

Door Handles and Accessories

page 3



## 1220 Symphony Series

Round Rose Door Handles

page 12



## 1420 Symphony Series

Square Rose Door Handles

page 29



## 1360 Series

Round Rose Door Handles

page 46



## 1370 Series

Round Rose Door Handles

page 62



## 260 Series Artefact Series

Round Rose Door Handles

page 78



## 260SQ Series

Square Rose Door Handles

page 80



## Ovation® Stainless Steel

Round Rose Door Handles

page 83



## Velocity® Series

Large Rose Door Furniture

page 90



## Velocity® Series

Small Rose Door Handles

page 94

# Robert Watson Series Door Handles

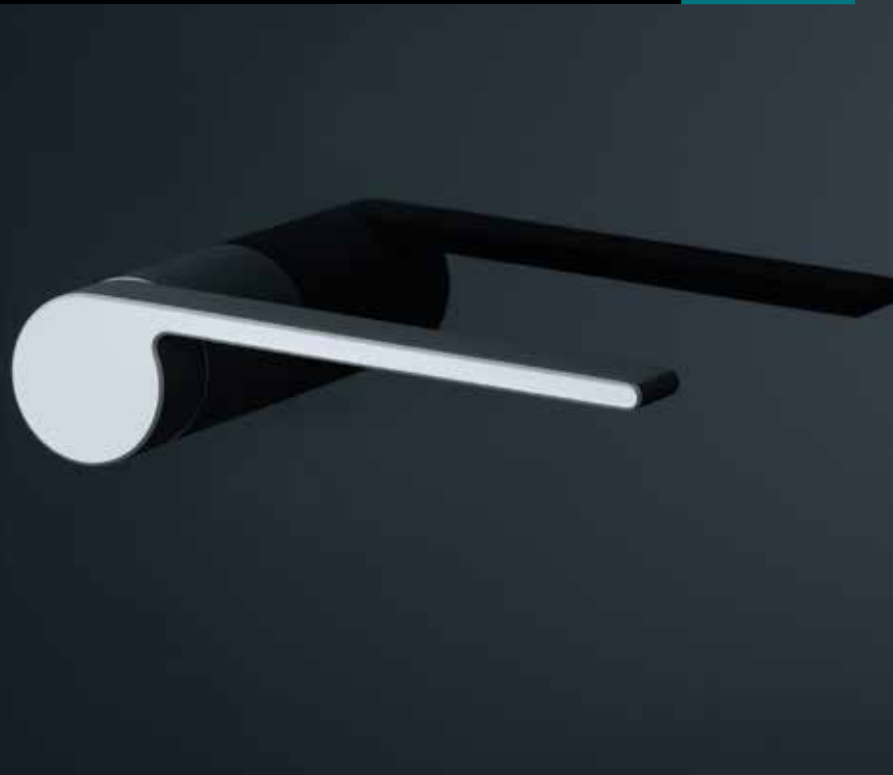

The Robert Watson Collection of door furniture consists of three lever designs and a range of complementing escutcheons, turnknobs and emergency release sets. The roseless design of the furniture is unprecedented and the innovation and lateral thinking involved in the development of the products has led to them being patent protected and design registered.

## Application

The Robert Watson range is suitable for commercial as well as residential use.

### It can be fitted with:

- Lockwood Selector 3770 Series Mortice Locks
- Lockwood Synergy 3570 Series Mortice Locks
- Lockwood 6780 and 6580 Mortice Locks (38mm backset, metal doors only)
- Lockwood 531 Latches and 6260 Tubular Bolts

## Fixing

Furniture is fixed to Selector 3770 or Synergy 3570 Series Mortice Locks using a specially developed pair of steel adaptor plates that are secured through the lock case using screws.



Robert Watson furniture may also be fitted with a Lockwood 531 Latch using a steel adaptor which locates over the body of the latch.

A special adaptor for fixing Robert Watson furniture to 6780 and 6580 Narrow Style Mortice Locks in hollow aluminium door sections is also available.

## Product Details

<b>Dimensions</b>	Body: 36mm diameter. Projection from door: 62.5mm.
<b>Materials</b>	Furniture body: aluminium. Mounting stock and other internal components: stainless steel, steel and brass.
<b>Door Thickness</b>	Selector 3770 and Synergy 3570 Series: 32mm to 50mm Selector 6780 and Synergy 6580 Series: 32mm to 50mm Lockwood 531 Latches: 35mm to 50mm  For Mortice Lock installation on doors 51mm to 62mm thick, use accessory pack RW00-42.
<b>Finishes</b>	Satin Anodised (SA) Powdercoat (PC)

## Standards and Compliance

	Successfully tested up to 4 hours on fire door assemblies in accordance with Australian Standard AS1905.1 2005 - Part 1: Fire Resistant Doorsets.
<b>S3</b>	High security for maximum protection (AS4145.2:1993).
<b>D8</b>	Tested to AS 4145.2 2008 for Durability to D8 - 500,000 cycles. Suitable for commercial applications.
	Tested to AS 4145.2 2008 for Neutral Salt Spray – Passing C6 Normal Corrosion Resistance - 168 Hours

# Robert Watson Levers

## Tangent - Lever A1

<b>Length</b>	143 mm
<b>Projection</b>	62.5 mm
<b>Finger Clearance</b>	44.5 mm

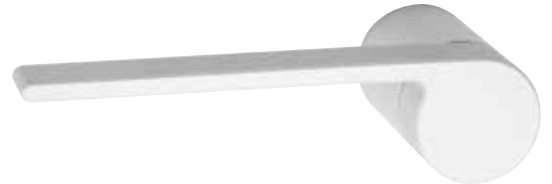
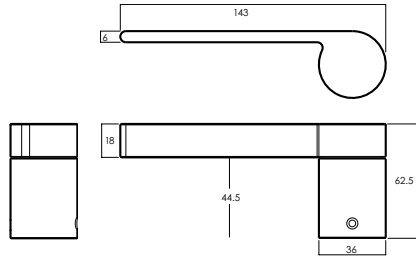

## Centre - Lever A2

<b>Length</b>	143 mm
<b>Projection</b>	62.5 mm
<b>Finger Clearance</b>	44.5 mm

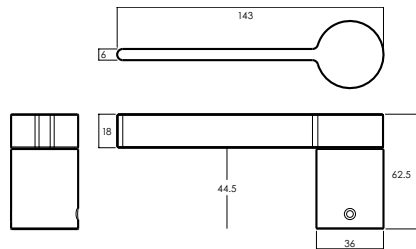

## Centre D - Lever A3

<b>Length</b>	143 mm
<b>Projection</b>	62.5 mm
<b>Finger Clearance</b>	44.5 mm

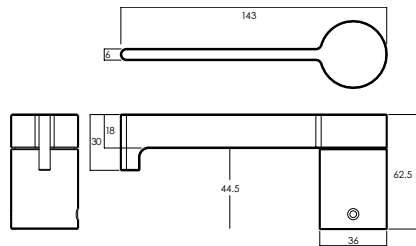



# Robert Watson Series Escutcheons



These escutcheons are designed to be fitted with Lockwood oval cylinders and the Robert Watson range of turnknobs and emergency turns. Fitted using a grub screw, they ensure that the accessories they are fitted with are aesthetically pleasing.

Use with Lockwood Mortice Locks and 6260 Bolts. The escutcheons are available in different sizes for suitability to different door thicknesses.

**Note:** Escutcheons must be ordered separately for use with oval cylinders, turnknobs and emergency release turns.

## Escutcheons

Part Numbers	Door Thickness	(A) Dimension
RW06/38	35–38mm thick	17mm
RW06/44	39–44mm thick	14mm
RW06/50	45–50mm thick	11mm
RW06/56	51–56mm thick*	8mm
RW06/62	57–62mm thick*	5mm

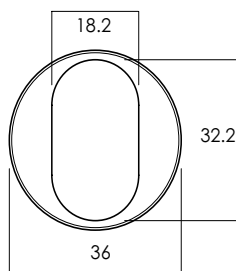

\*Extended door accessory pack required if levers are to be installed on doors of this thickness.

# Robert Watson Series Accessories

## Turnknob

**Part Number** RW07

\*Accessories—use with Selector 3770 and 6780 Series or Synergy 3570 and 6580 Series Mortice Locks.

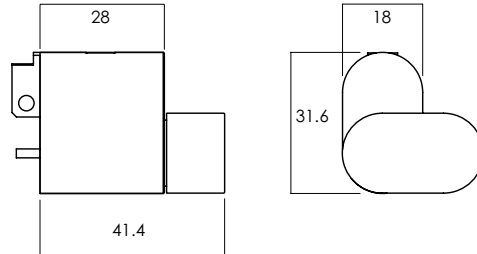

## Privacy Indicating Turnknob

**Part Number** RW08

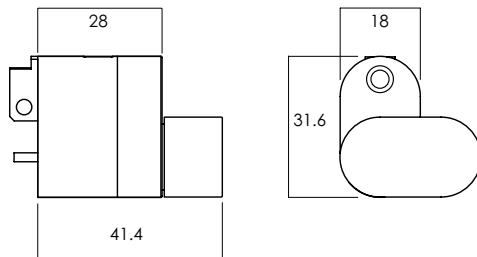

## Turnknob and Emergency Release Set

**Part Number** RW09

\*Accessories—use with Selector 3770 and 6780 Series or Synergy 3570 and 6580 Series Mortice Locks.

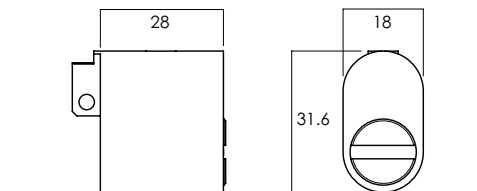

Exterior

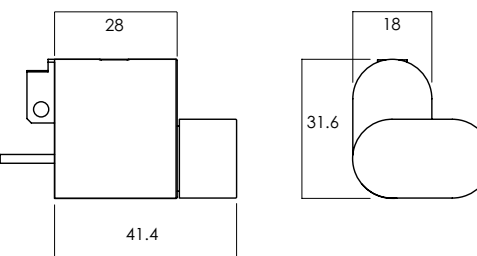

Interior

# Robert Watson Series Accessories

## Turnknob and Privacy Indicating Emergency Release Set

**Part Number** RW10

\*Accessories—use with Selector 3770 and 6780 Series or Synergy 3570 and 6580 Series Mortice Locks.

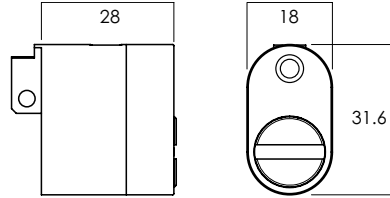

Exterior

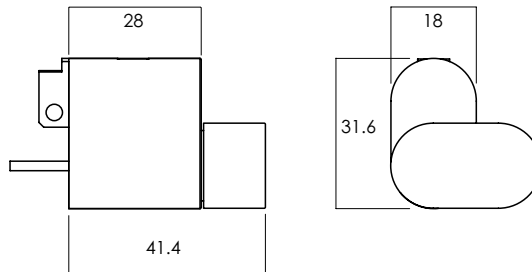

Interior

## Privacy Indicating Turnknob and Privacy Indicating Emergency Release Set

**Part Number** RW11

\*Accessories—use with Selector 3770 and 6780 Series or Synergy 3570 and 6580 Series Mortice Locks.

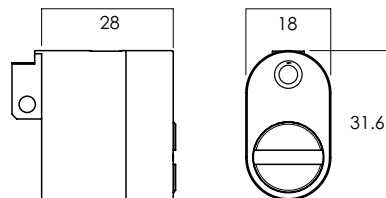

Exterior

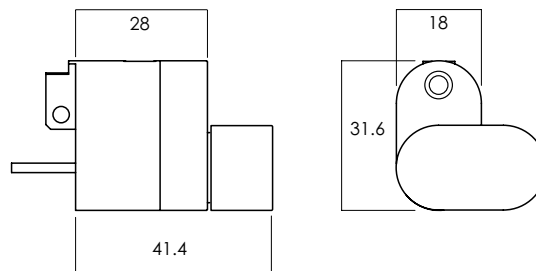

Interior

# Robert Watson Series Accessories

## Turnknob and Emergency Release Set

**Part Number** RW13

\*Accessories—use with Lockwood 6260 Tubular Bolt.

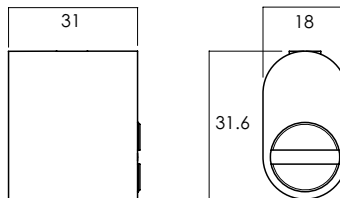

Exterior

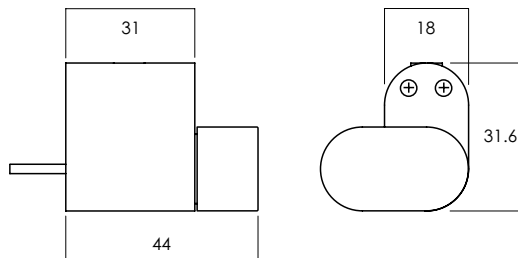

Interior

## Privacy Indicating Emergency Release

**Part Number** RW14

\*Accessories—use with Selector 3770 and 6780 Series or Synergy 3570 and 6580 Series Mortice Locks.

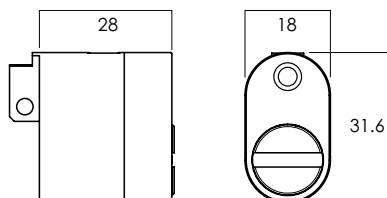

Exterior

## Accessories—Latch Kits

**Part Numbers** (Backset) Dimension

RW531/60SC 60mm

RW531/70SC 70mm

RW531/127SC 127mm

\*Latch kits are supplied with adaptors required to fit Robert Watson Levers.



# Robert Watson Series Accessories

Standard turn adaptors supplied with Selector 3770 Series Mortice Locks can be used with Robert Watson turnknobs, no special adaptors needed. Simply remove the plastic insert of the turn adaptors during installation. Refer to the list below for Selector Series turn adaptors.

## Selector 3770 Series Mortice Lock Turn Adaptors

Function	Adaptor
Locking Function	3772-ADAPTOR
Latching Function	3770-ADAPTOR



Special adaptors are required when using Robert Watson turnknobs with Synergy Series Mortice Locks. These can be ordered as spare parts. Refer to the list below.

## Synergy 3570 Series Mortice Lock Turn Adaptors

Function	Adaptor	Function	Adaptor
3570XTR	SP3570-6050	3572WTR	SP3572-6250
3570XTL	SP3570-6050	3572WTL	SP3572-6250
3570-TR	SP3570-6050	3572XAR	SP3572-6250
3570-TL	SP3570-6050	3572XAL	SP3572-6250
3571WTR	SP3571-6050	3573WTR	SP3571-6050
3571WTL	SP3571-6050	3573WTL	SP3571-6050
3571-TR	SP3571-6050	3573-TR	SP3571-6050
3571-TL	SP3571-6050	3573-TL	SP3571-6050
3572XTR	SP3572-6250	3574WTR	SP3572-6250
3572XTL	SP3572-6250	3574WTL	SP3572-6250
3572-TR	SP3572-6250	3574ETR	SP3572-6250
3572-TL	SP3572-6250	3574ETL	SP3572-6250

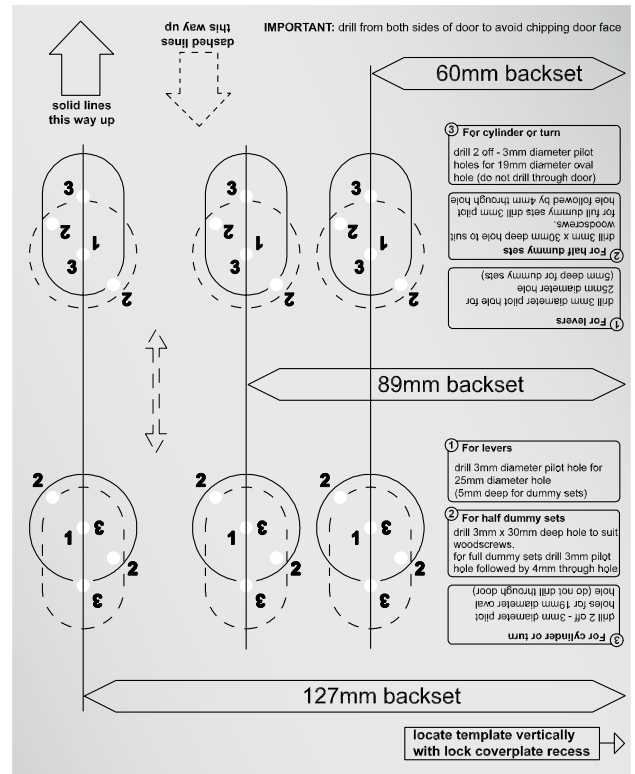

## Installation Fixtures

Part Numbers	Description
RW98	Template for Lockwood 6780/6580 Series Mortice Locks (metal doors only)
RW99	Template for Lockwood 3770/ 3570 Series Mortice Locks

This stainless steel fixture makes installation easy. It is ideal when fitting furniture for large projects.

**Note:** Paper templates are supplied with all furniture.

# Robert Watson Ordering Procedure

## Ordering Procedure–Lever Sets

Sample part number RW70/01/A1LSA is made up of several sections. Choose your product by selecting an option from each section.

### Robert Watson Collection

Product	Use	Function	Lever	Handing	Finish
RW	70	01	A1	L	SA

Product	Use	Function	Lever	Handing	Finish				
Robert Watson	RW	Operating Full Set	00	Tangent®	A1	Left Handed	L	Satin Anodised	SA
		Operating Half Set	01	Centre	A2	Right Handed	R	Powdercoat	PC
		Fixed Full Set	02	Centre D	A3	* Half sets only.			
		Fixed Half Set	03						
Use		<p>Note: Latch kits are ordered separately to lever sets. i.e. for RW30/00/A1LSA as RW531/60SC is also required.</p> <p>These include additional mounting hardware to suit lever sets and are not the same as a standard 530 latch.</p>							
If intended to fit using Lockwood 530 Latch		30							
If intended to fit using Lockwood 3770 and 3570 Series Mortice Locks		70							
If intended to fit using Lockwood 6780 and 6580 Narrow Style Mortice Lock (metal door only)		80							
If intended to fit to a metal door without lock		10							
If intended to fit to a timber door without lock		20							

### Escutcheons - Accessories

Product	Use	Thickness	Finish
RW	06	50	SA

Product	Use	Function	Finish		
Robert Watson	RW	Doors 57mm – 62mm	62	Satin Anodised	SA
		Doors 51mm – 56mm	56	Powdercoat	PC
		Doors 45mm – 50mm	50		
		Doors 39mm – 44mm	44		
		Doors 35mm – 38mm	38		

# Robert Watson Ordering Procedure

## Turnknobs and Emergency release turns - Accessories (For use with Lockwood Mortice Locks)

Product	Use	Finish
RW	07	SA

Product	Function	Finish
Robert Watson RW	Turnknob 07	Satin Anodised SA
	Privacy Indicating Turnknob 08	Powdercoat PC
	Turn Knob and Emergency Release Set 09	
	Turnknob/Privacy Indicating Emergency Release Set 10	
	Privacy Indicating Turnknob and Privacy Indicating Emergency Release Set 11	
	Privacy Indicating Emergency Release 14	

## Turnknob and Emergency Release Turns - Accessories (For use with Lockwood 6260 Tubular Bolts)

Product	Function	Finish
RW	13	SA

Product	Function	Finish
Robert Watson RW	Turnknob and Emergency Release Set 13	Satin Anodised SA
		Powdercoat PC

## Latch Kits - Accessories

Product	Latch	Backset	Finish
RW	531	60	SC

Product	Latch	Function	Finish
Robert Watson RW	Plain Latch 531	60mm backset 60	Satin Chrome SC
		70mm backset 70	
		127mm backset 127	

Latch Kits are supplied with adaptor to enable use with Robert Watson Furniture.

# 1220 Symphony Series Brass Door Handles



Lockwood Symphony Series door furniture is manufactured from high quality solid brass. The comprehensive lever range matched with concealed screw fixings by way of threaded rose trims, provides a stylish look for the most elegant interiors.

The accessory range includes cylinder escutcheons, emergency turnknob and disabled accessible turnknobs. For installers, the unique turn mechanism adjusts to suit the thickness of the door and removes the need to cut tailbars to length.

A full range of finishes from satin chrome through to a range of brass finishes and polyester powder coat provides all the options for matching to interior designs.

Proudly Australian Made at our factory in Oakleigh to the highest quality standards for strength, durability and corrosion resistance.

## Product Details

<b>Dimensions</b>	53mm diameter x 11.6mm.
<b>Handing</b>	A removable stop screw allows all symmetrically designed levers (e.g. Cadenza) to be handed on site. Levers of asymmetrical design (e.g. Veloce) cannot be reversed. Specify left or right handed when ordering.
<b>Materials</b>	All Lockwood roses and levers contained in the 1220 series are of solid brass construction.
<b>Fixing</b>	Fully concealed on both sides.
<b>Door Thickness</b>	Selector 3770 and Synergy 3570 Series: 32mm to 50mm Lockwood 5260 Latches: 33mm to 50mm
<b>Standard Finishes</b>	Satin Chrome Brushed (SC)
<b>Non-Standard Finishes</b>	Chrome Plate (CP) Polished Brass (PB) Polyester Powdercoat (PC)
<b>Special Finishes</b>	Architectural Bronze (AZ) Architectural Bronze Unlacquered (AU) Antique Copper (AC) Polished Brass Unlacquered (BU) Satin Brass (SB) Oil Rubbed Bronze (ORB)
<b>Privacy</b>	Privacy function for Symphony Round Rose Furniture is achieved using the 3890 privacy adaptor and the Symphony 1321 interior rose. See ordering procedure for details.

## Standards and Compliance



Successfully tested up to 4 hours on fire door assemblies in accordance with Australian Standard AS1905.1 2005 - Part 1: Fire Resistant Doorsets.

**S3**

High security for maximum protection (AS4145.2:2008).

**D8**

Tested to AS 4145.2 2008 for Durability – Passing D8 500,000 cycles. Suitable for commercial applications.



Tested to AS 4145.2 2008 for Neutral Salt Spray – with SC Finish passing C10 1000 Hours - Extreme Corrosion Resistance. Suitable for coastal applications.



Disabled Accessible. AS1428.1 Compliant Levers and Turnknobs as indicated.



Australian Made



# 1220 Symphony Series Brass Door Handles

The Symphony Series rose furniture features a 53mm solid brass rose with horizontal screw fixings, concealed on both sides by a threaded rose trim.

**Supplied with:**

- 2 x M4 x 65mm Stainless Steel Screws (SP1220-119)
- 1 x Instructions (1220-221)

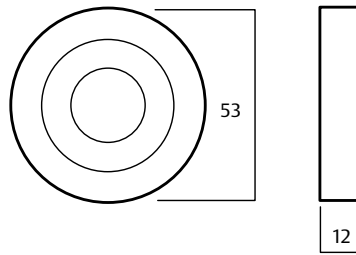

## AS1428.1 Compliant Levers

### Overture - Lever 59

<b>Length</b>	121mm
<b>Projection</b>	57.5mm
<b>Finger clearance</b>	38mm

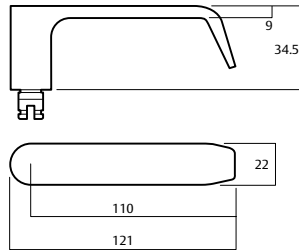

### Lever 70

<b>Length</b>	121mm
<b>Projection</b>	53mm
<b>Finger clearance</b>	37mm

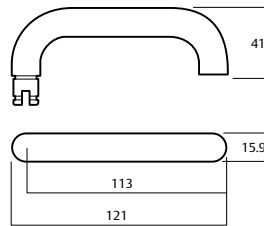

### Ving - Lever 74

<b>Length</b>	120mm
<b>Projection</b>	53mm
<b>Finger clearance</b>	45mm

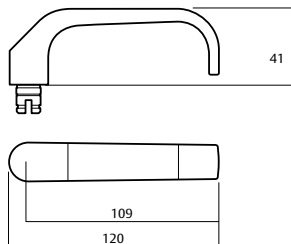

# 1220 Symphony Series Brass Door Handles

## AS1428.1 Compliant Levers

Lever 76	<b>NEW PRODUCT</b>
<b>Length</b>	125mm
<b>Projection</b>	50mm
<b>Finger clearance</b>	42mm

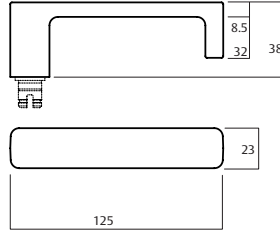

Lever 77	<b>NEW PRODUCT</b>
<b>Length</b>	121mm
<b>Projection</b>	51mm
<b>Finger clearance</b>	40.5mm

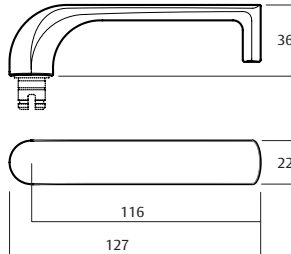

Lever 80	<b>NEW PRODUCT</b>
<b>Length</b>	123mm
<b>Projection</b>	49mm
<b>Finger clearance</b>	40mm

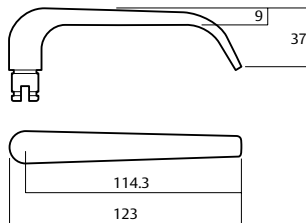

Lever 85	<b>NEW PRODUCT</b>
<b>Length</b>	125.5mm
<b>Projection</b>	51mm
<b>Finger clearance</b>	43.5mm

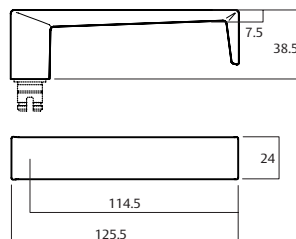

# 1220 Symphony Series Brass Door Handles

## AS1428.1 Compliant Levers

Lever 90	
<b>Length</b>	118.5mm
<b>Projection</b>	52mm
<b>Finger clearance</b>	45mm

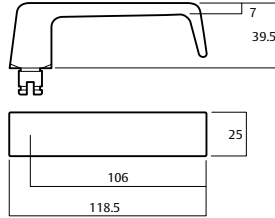

Lever 92	
<b>Length</b>	118.5mm
<b>Projection</b>	52mm
<b>Finger clearance</b>	45mm

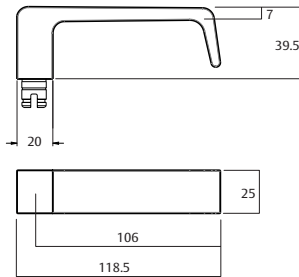

## Standard Knob and Levers

20 Knob	
<b>Diameter</b>	50mm
<b>Projection</b>	73mm

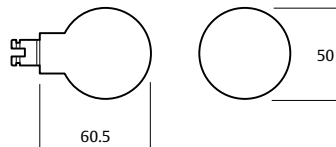

20 Knob can be used on outside rose only.

Lever 32	
<b>Length</b>	107.5mm
<b>Projection</b>	53mm
<b>Finger clearance</b>	35.5mm

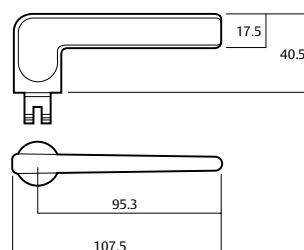

# 1220 Symphony Series Brass Door Handles

## Standard Knobs and Levers

### Intermezzo - Lever 41

<b>Length</b>	130mm
<b>Projection</b>	61.5mm
<b>Finger clearance</b>	40.5mm

\* Lever is an asymmetrical design and therefore must be handed.

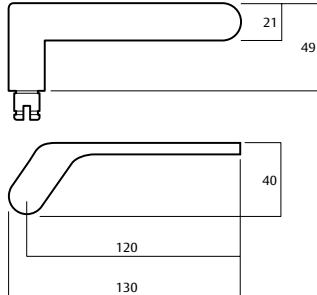

### Arpeggio - Lever 44

<b>Length</b>	125mm
<b>Projection</b>	59.5mm
<b>Finger clearance</b>	42mm

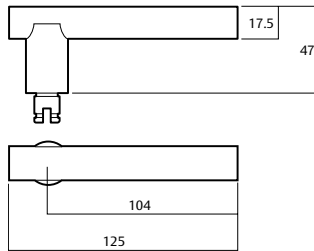

### Sonata - Lever 45

<b>Length</b>	117.5mm
<b>Projection</b>	57mm
<b>Finger clearance</b>	40mm

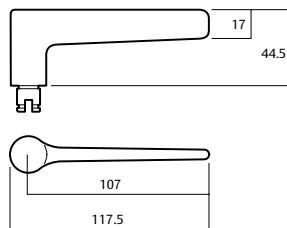

### Veloce - Lever 53

<b>Length</b>	123mm
<b>Projection</b>	73.5mm
<b>Finger clearance</b>	45mm

\*Lever is an asymmetrical design and therefore must be handed.

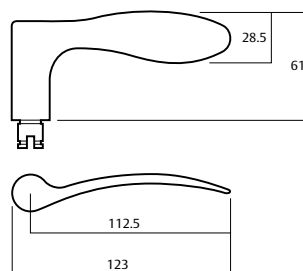

# 1220 Symphony Series Brass Door Handles

## Standard Knobs and Levers

### Lever 55

<b>Length</b>	124mm
<b>Projection</b>	62.5mm
<b>Finger clearance</b>	40.3mm

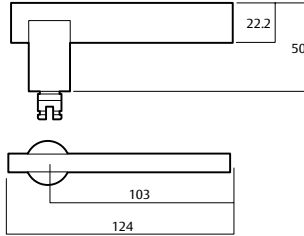

### Lever 55A

<b>Length</b>	115mm
<b>Projection</b>	62.5mm
<b>Finger clearance</b>	40.3mm

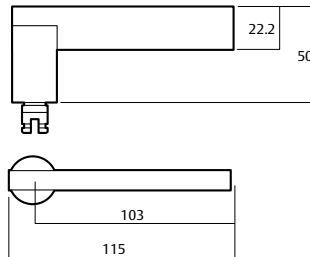

### Lever 60

<b>Length</b>	121mm
<b>Projection</b>	65mm
<b>Finger clearance</b>	54.2mm

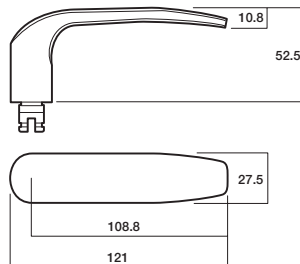

### Lever 61

<b>Length</b>	120mm
<b>Projection</b>	52.5mm
<b>Finger clearance</b>	25.5mm

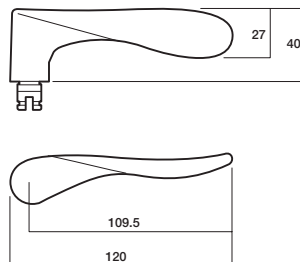

\*Lever is an asymmetrical design and therefore must be handed.

# 1220 Symphony Series Brass Door Handles

## Standard Knobs and Levers

Lever 65	<b>NEW PRODUCT</b>
<b>Length</b>	121mm
<b>Projection</b>	51mm
<b>Finger clearance</b>	43.5mm

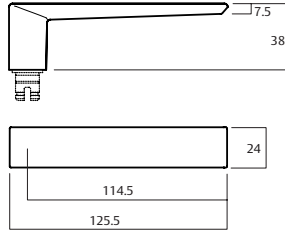

Lever 66	<b>NEW PRODUCT</b>
<b>Length</b>	125mm
<b>Projection</b>	50mm
<b>Finger clearance</b>	42mm

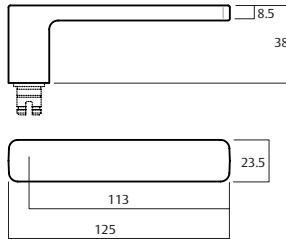

Lever 67	<b>NEW PRODUCT</b>
<b>Length</b>	127mm
<b>Projection</b>	48.5mm
<b>Finger clearance</b>	40.5mm

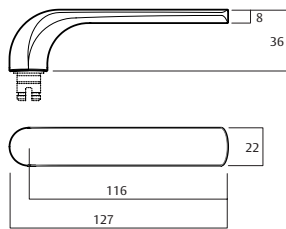

Tempo - Lever 71	
<b>Length</b>	118mm
<b>Projection</b>	62mm
<b>Finger clearance</b>	44.5mm

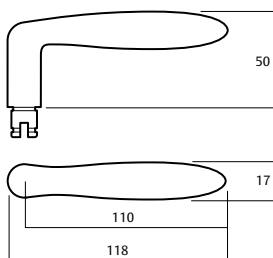

# 1220 Symphony Series Brass Door Handles

## Standard Knobs and Levers

### Cadenza - Lever 78

<b>Length</b>	118mm
<b>Projection</b>	52mm
<b>Finger clearance</b>	30mm

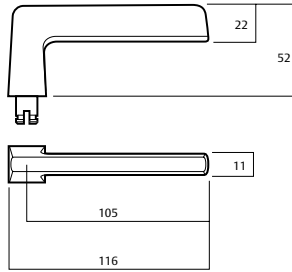

### Tenor - Lever 79

<b>Length</b>	124mm
<b>Projection</b>	50.5mm
<b>Finger clearance</b>	40.5mm

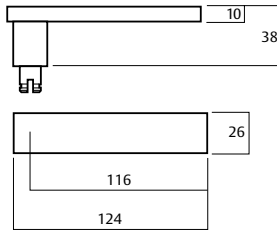

### Lever 79B

<b>Length</b>	118mm
<b>Projection</b>	50.5mm
<b>Finger clearance</b>	40.5mm

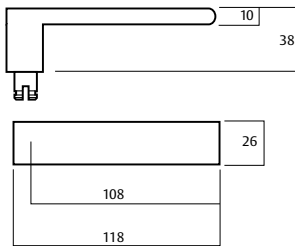

### Lever 83

<b>Length</b>	112mm
<b>Projection</b>	62mm
<b>Finger clearance</b>	33.5mm

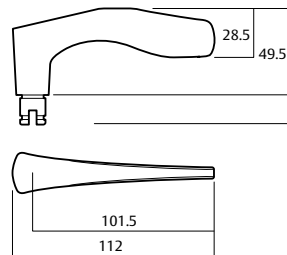

# 1220 Symphony Series Brass Door Handles

## Standard Knobs and Levers

### Chorus Line - Lever 97

<b>Length</b>	120mm
<b>Projection</b>	50.5mm
<b>Finger clearance</b>	34.6mm

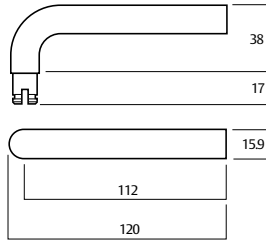



# 1220 Symphony Through Fix Escutcheon Kits

Designed for use with **Selector** Series Mortice Locks **only**, supplied with two M4 64mm stainless screws for through fix installation.

## Double Oval Cylinder Escutcheons Kit

**Part Number** 1226/6

### Escutcheons supplied

**Outside:** Oval Cylinder Escutcheon

**Inside:** Oval Cylinder Escutcheon

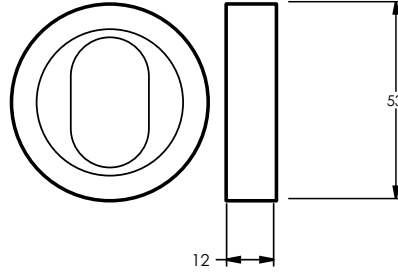

Outside

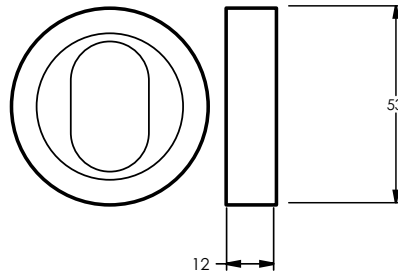

Inside

## Oval Cylinder and Turnknob Escutcheons Kit

**Part Number** 1226/7N

### Escutcheons supplied

**Outside:** Oval Cylinder Escutcheon

**Inside:** Turnknob Escutcheon

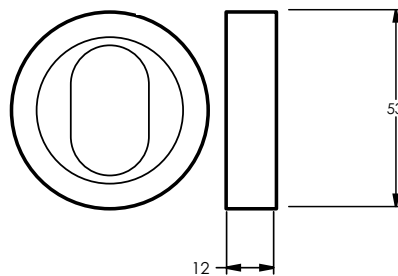

Outside

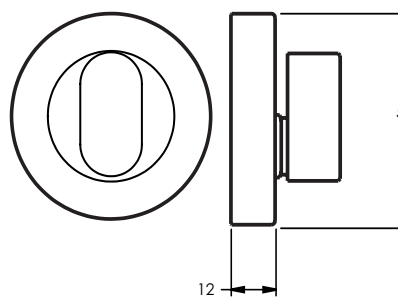

Inside

# 1220 Symphony Through Fix Escutcheon Kits

## Privacy Indicating Emergency Turn and Disabled Accessible Turnknob Escutcheons Kit

**Part Number** 1228/9P

### Escutcheons supplied

**Outside:** Privacy Indicating Emergency Turn Escutcheon

**Inside:** Privacy Indicating Disabled Accessible Turnknob Escutcheon

**Note:** Kits with Disabled Accessible Turnknobs require handing.

Handing is based on the door, same as handing of a full set of rose door lever handles.

A left-handed escutcheon kit suits a left-handed door and will be supplied with a right-handed disabled accessible turnknob, as this turnknob is intended to be used on the interior side of the door.

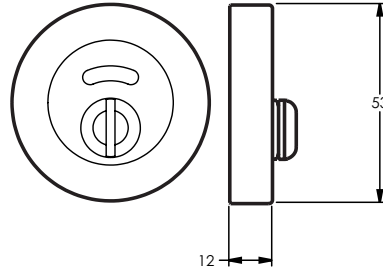

Outside

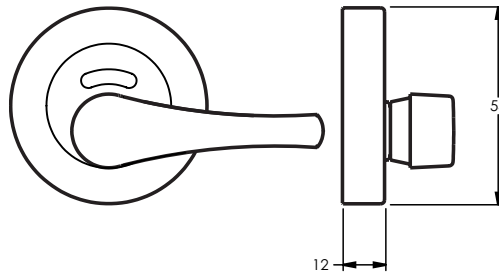

Inside

### HAND OF DOOR ACCORDING TO ENGLISH PRACTICE

DOOR OPENING IN		DOOR OPENING OUT	
<p>INSIDE</p> <p>RIGHT HAND KIT      LEFT HAND KIT</p> <p>OUTSIDE</p>	<p>INSIDE</p> <p>RIGHT HAND KIT      LEFT HAND KIT</p> <p>OUTSIDE</p>		

**Note:** Common kit configurations are shown, for other kit variations please refer to the ordering procedure at the end of this section.

# 1220 Symphony Cylinder & Turn Escutcheons

Designed for use with **Synergy** Series Mortice Locks, with two horizontal fixing holes, concealed by a threaded rose trim.

## Oval Cylinder Escutcheon

**Part Number** 1226/I

### Supplied with

2x Short & 2x Medium Wood Screws (SP1226-219)

(Replaces 1226)

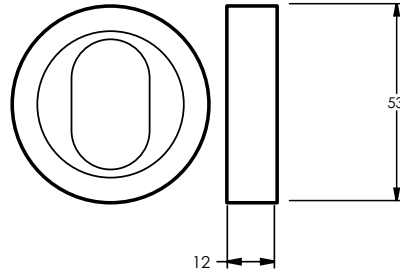

## Turnknob Escutcheon

**Part Number** 1227/IN

### Supplied with

2 x Short & 2 x Medium Wood Screws (SP1226-219)

1 x Short, Medium & Long Tail Bars and Spring (SP1227-219)

1 x Flat Tail Bar & Split Pin (SP12227-319)

1 x Instructions (1220-321)

(Replaces 1227)

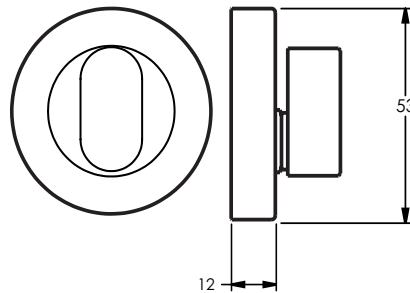

## Privacy Indicating Turnknob Escutcheon

**Part Number** 1227/IP

### Supplied with

2 x Short & 2 x Medium Wood Screws (SP1226-219)

1 x Short, Medium & Long Tail Bars and Spring (SP1227-219)

1 x Flat Tail Bar & Split Pin (SP12227-319)

1 x Instructions (1220-321)

(Replaces 1227P)

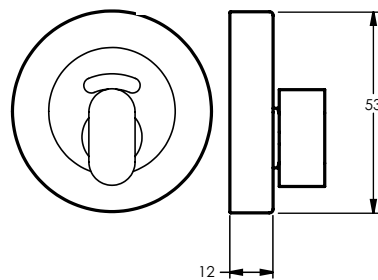

## Emergency Turn Escutcheon

**Part Number** 1228/IN

### Supplied with

2 x Short & 2 x Medium Wood Screws (SP1226-219)

1 x Emergency Tail Bar (SP1227-119)

(Replaces 1228)

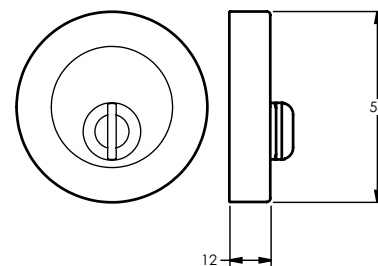

# 1220 Symphony Cylinder & Turn Escutcheons

## Privacy Indicating Emergency Turn Escutcheon

**Part Number** 1228/IP

### Supplied with

2 x Short & 2 x Medium Wood Screws (SP1226-219)  
1 x Emergency Tail Bar (SP1227-119)

(Replaces 1228P)

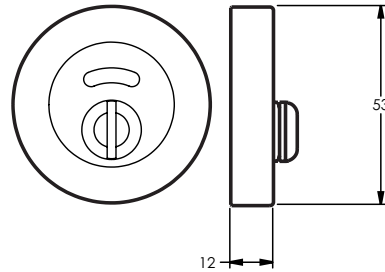

## Disabled Accessible Turnknob

**Part Number** 1229/IN

### Supplied with

2 x Short & 2 x Medium Wood Screws (SP1226-219)  
1 x Short, Medium & Long Tail Bars and Spring (SP1227-219)  
1 x Instructions (1220-321)

(Replaces 1227DT)

**Note:** Disabled Accessible Turns require handing.

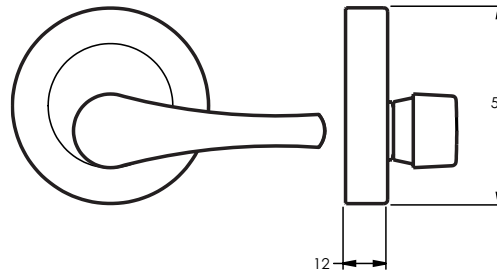

## Disabled Accessible Privacy Indicating Turnknob

**Part Number** 1229/IP

### Supplied with

2 x Short & 2 x Medium Wood Screws (SP1226-219)  
1 x Short, Medium & Long Tail Bars and Spring (SP1227-219)  
1 x Instructions (1220-321)

**Note:** Disabled Accessible Turns require handing.

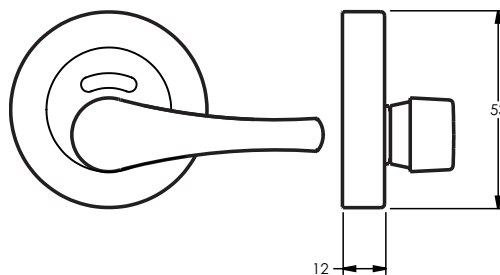

# 1220 Symphony Privacy Adaptor

## Privacy Adaptor

**Part Number** 3890

**Dimensions** 52mm x 11.6mm

### Supplied with

2 x M4 x 77mm Stainless Steel Screws (SP0655MBK)  
1 x Spindle 7.6mm x 90mm  
1 x Instructions (3890-121)

### Finishes

Satin Chrome (SC)  
Chrome Plate (CP)  
Powder Coat (PC)  
  
Not available in  
brass finishes

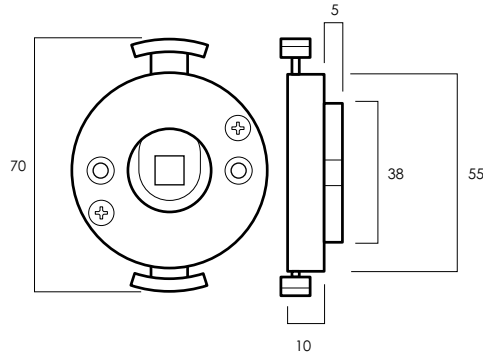

The 3890 Privacy Adaptor has a patented built in clutching mechanism which allows the engaged mode to be overridden by use of specified force applied in a single downward action on the lever. This will allow entry in an emergency situation without the use of any type of tool.

The privacy adaptor can be installed onto any existing Lockwood lever set and standard 5260 Tubular Latch.

# 1220 Symphony Series Ordering Procedure

Sample part number 1220/1221/41LCP is made up of several sections. Choose your product by selecting an option from each section.

## Half Set

**Note:** Choose one rose only, exterior or interior.

Exterior Rose	Lever/ Knob	Handing	Finish
1220	41	L	CP

## Full Set

Exterior Rose	Interior Rose	Lever/ Knob	Handing	Finish
1220	1221	41	L	CP

Exterior Rose Type	
Exterior Rose	1220
Exterior Blank Rose	1222
Exterior Fixed Rose	1224

Interior Rose Type	
Interior Rose	1221
Interior Blank Rose	1223
Interior Fixed Rose	1225
Interior Rose to suit 3890 Privacy Adaptor	
<small>*Only available in SC,CP and PC</small>	1321

Lever/Knob Type		
20	32	44
45	55	55A
60	65	66
67	71	78
79	79B	83
97		

AS1428.1 Compliant Levers		
59	76	85*
70	77	90
74	80	92

Handed Levers		
41	53	61

\* Lever 85 is not available in CP

Handing	
Right Handed	R
Left Handed	L
<small>NB: Omit if non-handed</small>	

Finish	
Satin Chrome Brushed	SC
Chrome Plate	CP
Polished Brass	PB
Polyester Powdercoat	PC*

Special Finishes	
Polished Brass Unlacquered	BU
Satin Brass	SB
Architectural Bronze	AZ
Architectural Bronze Unlacquered	AU
Antique Copper	AC
Oil Rubbed Bronze	ORB

\* For the powdercoat color range, please see the Dulux Powdercoat Range at the end of the plate furniture catalogue section.

# 1220 Symphony Series Ordering Procedure

## Selector Series Escutcheon Kits

Designed for use with Selector Mortice Locks only, all escutcheon kits are supplied with two M4 65mm stainless steel screws to allow for through fix installation.

Sample part number 1226/9NLSC is made up of several sections. The description of this part number is a left-handed oval cylinder and disabled accessible turnknob escutcheon kit.

Exterior Function	Interior Function	Privacy Indicator	Handing	Finish
1226	9	N	L	SC

Exterior Function	
Oval Cylinder	1226
Emergency Turn	1228
<b>Notes:</b> Order 1226/I if only one oval cylinder escutcheon is required. Wood screws will be supplied for surface mounting.	
1228/6 Kit is not applicable.	

Interior Function	
Oval Cylinder	6
Oval Turnknob	7
Disabled Accessible Turnknob	9

Privacy Indicator	
Oval Cylinder	-
Non Indicating	N
Privacy Indicating	P
<b>Note:</b> Privacy indicator applies for both exterior and interior functions.	

Handing	
Right Handed	R
Left Handed	L

**Note:**  
Handing is based on the door, same as handing of a full set of rose door lever handles.

The sample part number shown above suits a left-handed door. This kit will be supplied with a right-handed disabled accessible turnknob, as the turnknob is intended to be used on the interior side of the door.

Only Kits with Disabled Accessible Turnknobs require handing.

Finish	
Satin Chrome Brushed	SC
Chrome Plate	CP
Polished Brass	PB
Polyester Powdercoat	PC*

Special Finishes	
Polished Brass Unlacquered	BU
Satin Brass	SB
Architectural Bronze	AZ
Architectural Bronze Unlacquered	AU
Antique Copper	AC
Oil Rubbed Bronze	ORB

\* For the powdercoat color range, please see the Dulux Powdercoat Range at the end of the plate furniture catalogue section.

# 1220 Symphony Series Ordering Procedure

## Synergy Series Escutcheons

Designed for use with Synergy Series Mortice Locks.  
All escutcheons are supplied with wood screws to suit surface mounting on either side of the door.

Escutcheon Type	Fixing	Privacy Indicator	Handing	Finish
1229	I	P	L	SC

Escutcheon Type	
Oval Cylinder	1226
Oval Turnknob	1227
Emergency Turn	1228
Disabled Accessible Turnknob	1229*

**Note:**  
\*Cannot be used with Selector Mortice Locks, please order escutcheon kits if needed.

Fixing	
Wood Screw	
Surface Fixing	I

Privacy Indicator	
Oval Cylinder	-
Non Indicating	N
Privacy Indicating	P

Handing	
Left Hand	L
Right Hand	R

NB: Only Disabled Accessible Turnknobs require handing

Finish	
Satin Chrome Brushed	SC
Chrome Plate	CP
Polished Brass	PB
Polyester Powdercoat	PC*

Special Finishes	
Polished Brass Unlacquered	BU
Satin Brass	SB
Architectural Bronze	AZ
Architectural Bronze Unlacquered	AU
Antique Copper	AC
Oil Rubbed Bronze	ORB

\* For the powdercoat color range, please see the Dulux Powdercoat Range at the end of the plate furniture catalogue section.



# 1420 Symphony Series Square Rose Door Handles



Lockwood Symphony Series door furniture is manufactured from high quality solid brass material. The comprehensive lever range matched with concealed screw fixings by way of threaded rose trims, provides a stylish look for the most elegant interiors.

The accessory range includes cylinder escutcheons, emergency turnknobs and disabled accessible turnknobs. For installers, the unique turn mechanism adjusts to suit the thickness of the door and removes the need to cut tailbars to length.

A full range of finishes from satin chrome through to a range of brass finishes and polyester powder coat provides all the options for matching to interior designs.

Proudly Australian Made at our factory in Oakleigh to the highest quality standards for strength, durability and corrosion resistance.

## Product Details

<b>Dimensions</b>	58mm x 58mm x 11.6mm.
<b>Handing</b>	A removable stop screw allows all symmetrically designed levers (e.g. Cadenza) to be handed on site. Levers of asymmetrical design (e.g. Veloce) cannot be reversed. Specify left or right handed when ordering.
<b>Materials</b>	All Lockwood roses and levers contained in the 1420 series are of solid brass construction.
<b>Fixing</b>	Fully concealed on both sides.
<b>Door Thickness</b>	Selector 3770 and Synergy 3570 Series: 32mm to 50mm Lockwood 5260 Latches: 33mm to 50mm
<b>Standard Finishes</b>	Satin Chrome Brushed (SC)
<b>Non-Standard Finishes</b>	Chrome Plate (CP) Polished Brass (PB) Polyester Powdercoat (PC)
<b>Special Finishes</b>	Architectural Bronze (AZ) Architectural Bronze Unlacquered (AU) Antique Copper (AC) Polished Brass Unlacquered (BU) Satin Brass (SB) Oil Rubbed Bronze (ORB)
<b>Privacy</b>	Privacy function for Symphony Square Rose Furniture is achieved using the 3690 privacy adaptor and standard Symphony 1421 interior rose.

## Standards and Compliance



Successfully tested up to 4 hours on fire door assemblies in accordance with Australian Standard AS1905.1 2005 - Part 1: Fire Resistant Doorsets.

**S3**

High security for maximum protection (AS4145.2:2008).

**D8**

Tested to AS 4145.2 2008 for Durability – Passing D8 500,000 cycles. Suitable for commercial applications.



Tested to AS 4145.2 2008 for Neutral Salt Spray – With SC Finish passing C10 1000 Hours - Extreme Corrosion Resistance. Suitable for coastal applications.



Disabled Accessible. AS1428.1 Compliant Levers and Turnknobs as indicated.



Australian Made

# 1420 Symphony Series Square Rose Door Handles

The Symphony Series square rose furniture features a 58mm solid brass rose with horizontal screw fixings, concealed on both sides by a grub screw fixed, square rose trim.

**Supplied with:**

2 x M4 x 65mm Stainless Steel Screws (SP1220-119)  
1 x Instructions (1220-221)

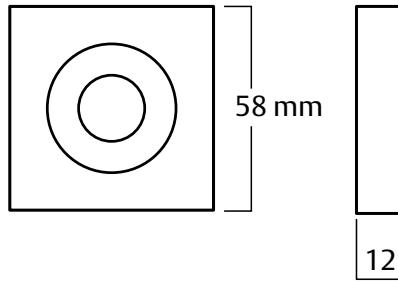

## AS1428.1 Compliant Levers

Overture - Lever 59	
<b>Length</b>	121mm
<b>Projection</b>	57.5mm
<b>Finger clearance</b>	38mm

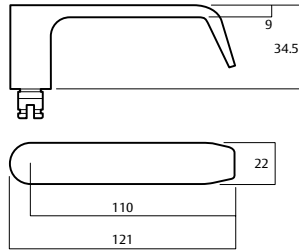

Lever 70	
<b>Length</b>	121mm
<b>Projection</b>	53mm
<b>Finger clearance</b>	37mm

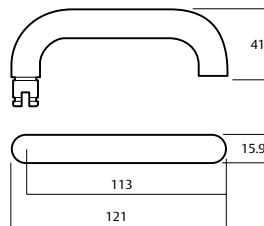

Ving - Lever 74	
<b>Length</b>	120mm
<b>Projection</b>	53mm
<b>Finger clearance</b>	45mm

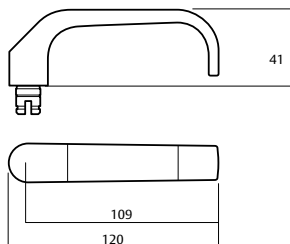

# 1420 Symphony Series Square Rose Door Handles

## AS1428.1 Compliant Levers

Lever 76	<b>NEW PRODUCT</b>
<b>Length</b>	125mm
<b>Projection</b>	50mm
<b>Finger clearance</b>	42mm

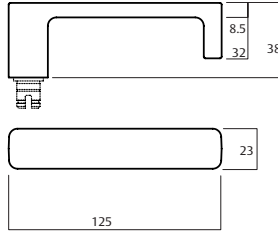

Lever 77	<b>NEW PRODUCT</b>
<b>Length</b>	121mm
<b>Projection</b>	51mm
<b>Finger clearance</b>	40.5mm

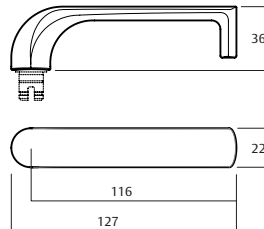

Lever 80	
<b>Length</b>	123mm
<b>Projection</b>	49mm
<b>Finger clearance</b>	40mm

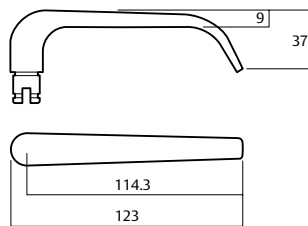

Lever 85	<b>NEW PRODUCT</b>
<b>Length</b>	125.5mm
<b>Projection</b>	51mm
<b>Finger clearance</b>	43.5mm

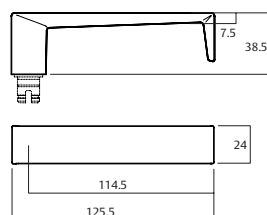

# 1420 Symphony Series Square Rose Door Handles

## AS1428.1 Compliant Levers

Lever 90	
<b>Length</b>	118.5mm
<b>Projection</b>	52mm
<b>Finger clearance</b>	45mm

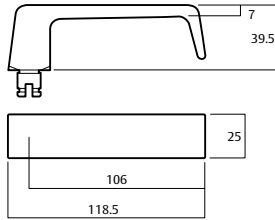

Lever 92	
<b>Length</b>	118.5mm
<b>Projection</b>	52mm
<b>Finger clearance</b>	45mm

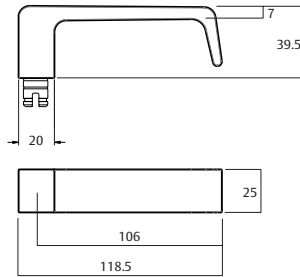

## Standard Knobs and Levers

20 Knob	
<b>Diameter</b>	50mm
<b>Projection</b>	73mm

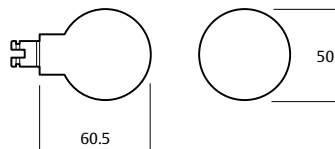

Not compatible with 1220 Symphony internal rose.

Lever 32	
<b>Length</b>	107.5mm
<b>Projection</b>	53mm
<b>Finger clearance</b>	35.5mm

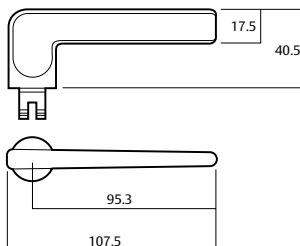

# 1420 Symphony Series Square Rose Door Handles

## Standard Knobs and Levers

### Intermezzo - Lever 41

<b>Length</b>	130mm
<b>Projection</b>	61.5mm
<b>Finger clearance</b>	40.5mm

\* Lever is an asymmetrical design and therefore must be handed.

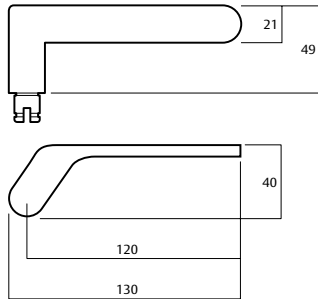

### Arpeggio - Lever 44

<b>Length</b>	125mm
<b>Projection</b>	59.5mm
<b>Finger clearance</b>	42mm

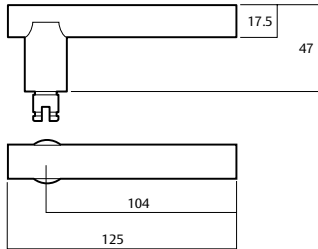

### Sonata - Lever 45

<b>Length</b>	117.5mm
<b>Projection</b>	57mm
<b>Finger clearance</b>	40mm

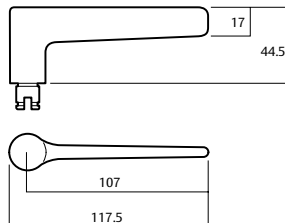

### Veloce - Lever 53

<b>Length</b>	123mm
<b>Projection</b>	73.5mm
<b>Finger clearance</b>	45mm

\*Lever is an asymmetrical design and therefore must be handed.

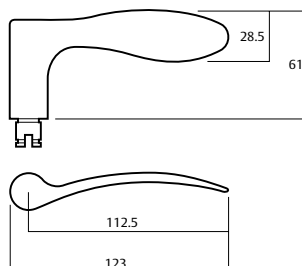

# 1420 Symphony Series Square Rose Door Handles

## Standard Knobs and Levers

### Lever 55

<b>Length</b>	124mm
<b>Projection</b>	62.5mm
<b>Finger clearance</b>	40.3mm

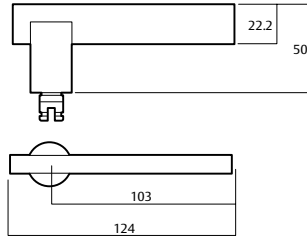

### Lever 55A

<b>Length</b>	115mm
<b>Projection</b>	62.5mm
<b>Finger clearance</b>	40.3mm

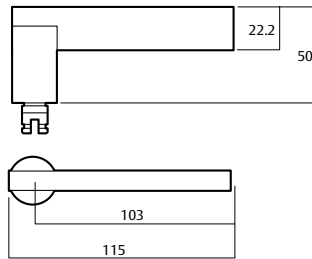

### Lever 60

<b>Length</b>	121mm
<b>Projection</b>	65mm
<b>Finger clearance</b>	54.2mm

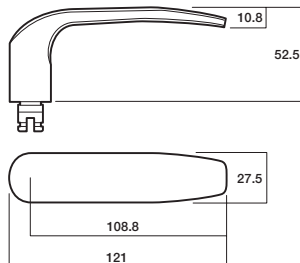

### Lever 61

<b>Length</b>	120mm
<b>Projection</b>	52.5mm
<b>Finger clearance</b>	25.5mm

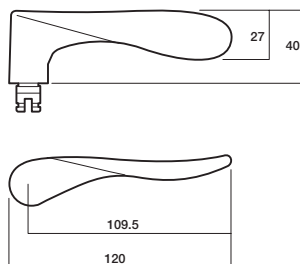

\*Lever is an asymmetrical design and therefore must be handed.

# 1420 Symphony Series Square Rose Door Handles

## Standard Knobs and Levers

Lever 65	<b>NEW PRODUCT</b>
<b>Length</b>	121mm
<b>Projection</b>	51mm
<b>Finger clearance</b>	43.5mm

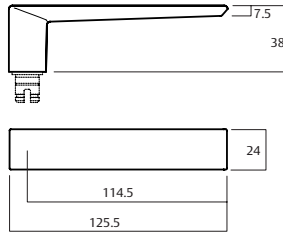

Lever 66	<b>NEW PRODUCT</b>
<b>Length</b>	125mm
<b>Projection</b>	50mm
<b>Finger clearance</b>	42mm

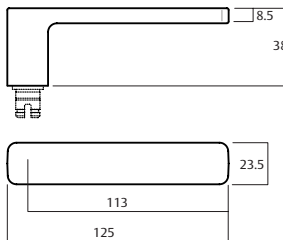

Lever 67	<b>NEW PRODUCT</b>
<b>Length</b>	127mm
<b>Projection</b>	48.5mm
<b>Finger clearance</b>	40.5mm

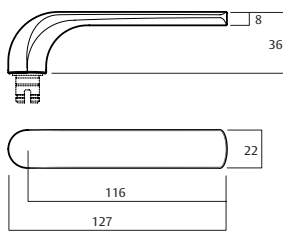

Tempo - Lever 71	
<b>Length</b>	118mm
<b>Projection</b>	62mm
<b>Finger clearance</b>	44.5mm

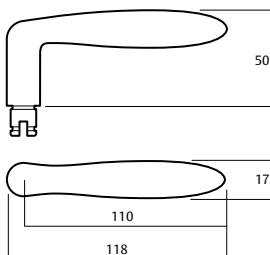

# 1420 Symphony Series Square Rose Door Handles

## Standard Knobs and Levers

### Cadenza - Lever 78

<b>Length</b>	118mm
<b>Projection</b>	52mm
<b>Finger clearance</b>	30mm

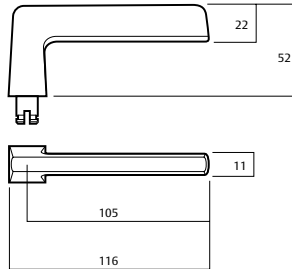

### Tenor - Lever 79

<b>Length</b>	124mm
<b>Projection</b>	50.5mm
<b>Finger clearance</b>	40.5mm

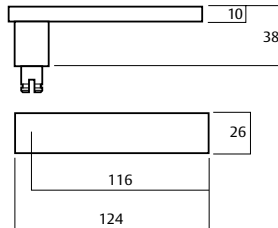

### Lever 79B

<b>Length</b>	118mm
<b>Projection</b>	50.5mm
<b>Finger clearance</b>	40.5mm

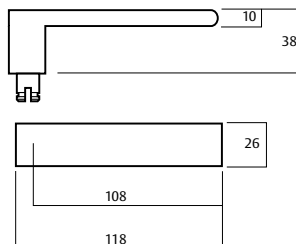

### Lever 83

<b>Length</b>	112mm
<b>Projection</b>	62mm
<b>Finger clearance</b>	33.5mm

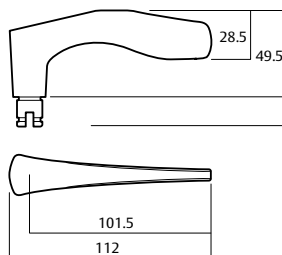



# 1420 Symphony Series Square Rose Door Handles

## Standard Knobs and Levers

### Chorus Line - Lever 97

<b>Length</b>	120mm
<b>Projection</b>	50.5mm
<b>Finger clearance</b>	34.6mm

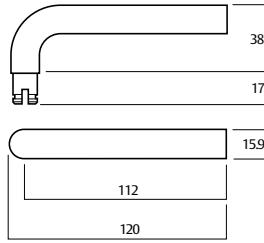

# 1420 Symphony Through Fix Escutcheon Kits

Designed for use with **Selector** Series Mortice Locks **only**, supplied with two M4 64mm stainless screws for through fix installation.

## Double Oval Cylinder Escutcheons Kit

**Part Number** 1426/6

### Escutcheons supplied

**Outside:** Oval Cylinder Escutcheon

**Inside:** Oval Cylinder Escutcheon

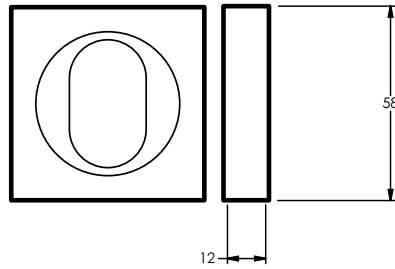

Outside

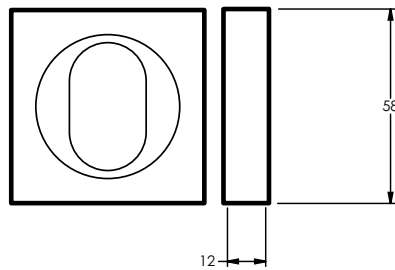

Inside

## Oval Cylinder and Turnknob Escutcheons Kit

**Part Number** 1426/7N

### Escutcheons supplied

**Outside:** Oval Cylinder Escutcheon

**Inside:** Turnknob Escutcheon

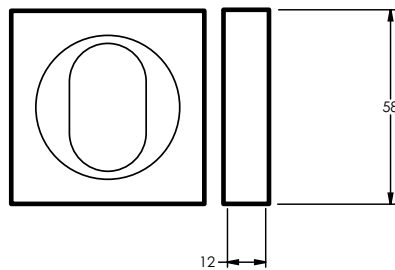

Outside

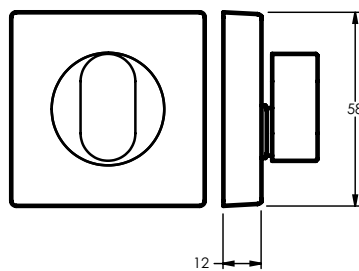

Inside

# 1420 Symphony Through Fix Escutcheon Kits

## Privacy Indicating Emergency Turn and Disabled Accessible Turnknob Escutcheons Kit

**Part Number** 1428/9P

### Escutcheons supplied

**Outside:** Privacy Indicating Emergency Turn Escutcheon

**Inside:** Privacy Indicating Disabled Accessible Turnknob Escutcheon

**Note:** Kits with Disabled Accessible Turnknobs require handing.

Handing is based on the door, same as handing of a full set of rose door lever handles.

A left-handed escutcheon kit suits a left-handed door and will be supplied with a right-handed disabled accessible turnknob, as this turnknob is intended to be used on the interior side of the door.

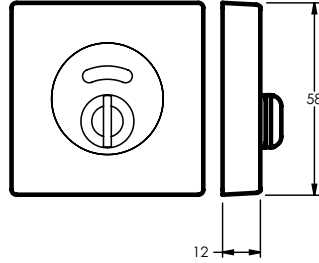

Outside

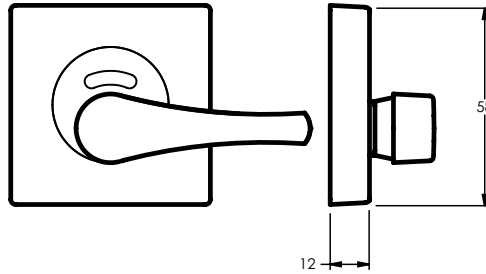

Inside

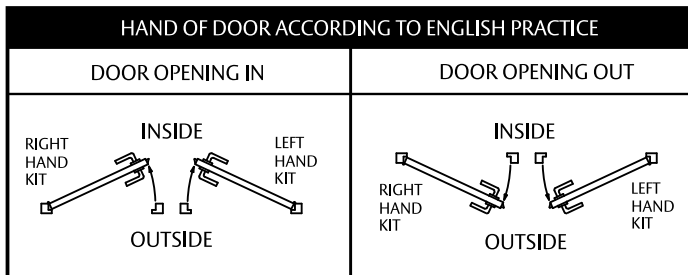

**Note:** Common kit configurations are shown, for other kit variations please refer to the ordering procedure at the end of this section.

# 1420 Symphony Cylinder & Turn Escutcheons

Designed for use with **Synergy** Series Mortice Locks, with two horizontal fixing holes, concealed by a grub screw fixed, square rose trim.

## Oval Cylinder Escutcheon

**Part Number** 1426/I

### Supplied with

2 x Short & 2 x Medium Wood Screws (SP1226-219)

(Replaces 1426)

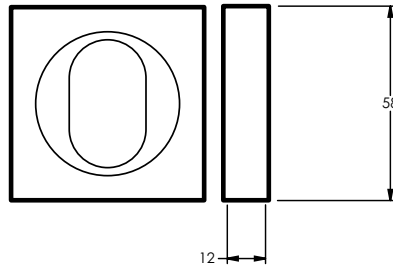

## Turnknob Escutcheon

**Part Number** 1427/IN

### Supplied with

2 x Short & 2 x Medium Wood Screws (SP1226-219)

1 x Short, Medium & Long Tail Bars and Spring (SP1227-219)

1 x Flat Tail Bar & Split Pin (SP12227-319)

1 x Instructions (1220-321)

(Replaces 1427)

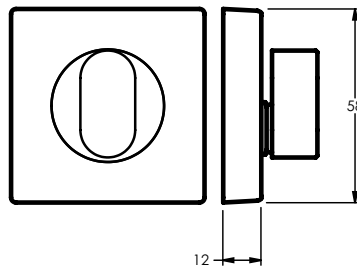

## Privacy Indicating Turnknob Escutcheon

**Part Number** 1427/IP

### Supplied with

2 x Short & 2 x Medium Wood Screws (SP1226-219)

1 x Short, Medium & Long Tail Bars and Spring (SP1227-219)

1 x Flat Tail Bar & Split Pin (SP12227-319)

1 x Instructions (1220-321)

(Replaces 1427P)

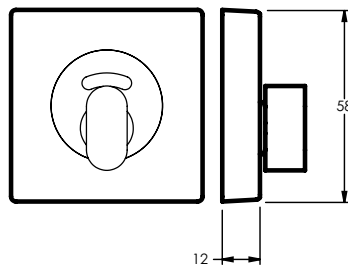

## Emergency Turn Escutcheon

**Part Number** 1428/IN

### Supplied with

2 x Short & 2 x Medium Wood Screws (SP1226-219)

1 x Emergency Tail Bar (SP1227-119)

(Replaces 1428P)

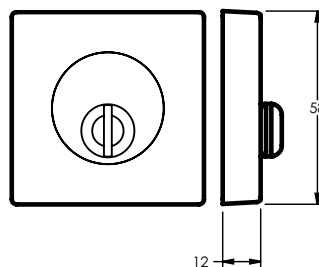

# 1420 Symphony Cylinder & Turn Escutcheons

## Privacy Indicating Emergency Turn Escutcheon

**Part Number** 1428/IP

### Supplied with

2 x Short & 2 x Medium Wood Screws (SP1226-219)  
1 x Emergency Tail Bar (SP1227-119)

(Replaces 1428P)

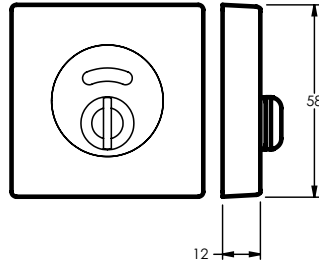

## Disabled Accessible Turnknob

**Part Number** 1429/IN

### Supplied with

2 x Short & 2 x Medium Wood Screws (SP1226-219)  
1 x Short, Medium & Long Tail Bars and Spring (SP1227-219)  
1 x Flat Tail Bar & Split Pin (SP1227-319)  
1 x Instructions (1220-321)

(Replaces 1427DT)

**Note:** Disabled Accessible Turnknob require handing.

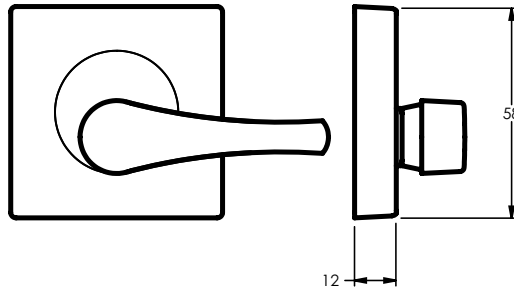

## Disabled Accessible Privacy Indicating Turnknob

**Part Number** 1429/IP

### Supplied with

2 x Short & 2 x Medium Wood Screws (SP1226-219)  
1 x Short, Medium & Long Tail Bars and Spring (SP1227-219)  
1 x Flat Tail Bar & Split Pin (SP1227-319)  
1 x Instructions (1220-321)

**Note:** Disabled Accessible Turnknob require handing.

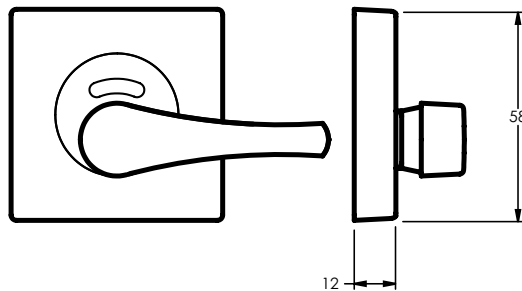

# 1420 Symphony Privacy Adaptor

## Privacy Adaptor 3690

**Part Number** 3690

**Dimensions** 58mm x 11.6mm

**Supplied with**

2 x M4 x 77mm Stainless Steel Screws (SP0655MBK)  
1 x Spindle 7.6mm x 90mm  
1 x Instructions (3890-121)

**Finishes**

Satin Chrome (SC)  
Chrome Plate (CP)  
Powder Coat (PC)  
Not available in  
brass finishes

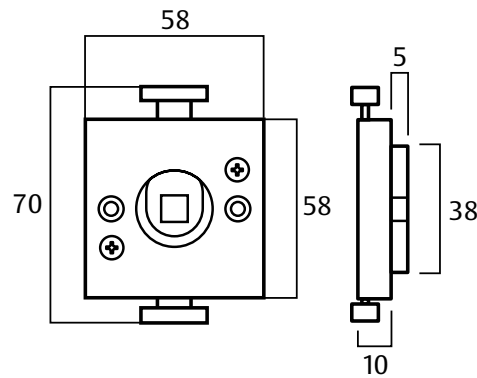

The 3690 Privacy Adaptor has a patented built in clutching mechanism which allows the engaged mode to be overridden by use of specified force applied in a single downward action on the lever. This will allow entry in an emergency situation without the use of any type of tool.

The privacy adaptor can be installed onto any existing Lockwood lever set and standard 5260 Tubular Latch.

# 1420 Symphony Series Ordering Procedure

## Ordering Procedure

Sample part number 1420/1421/41LCP is made up of several sections. Choose your product by selecting an option from each section.

## Half Set

**Note:** Choose one rose only, exterior or interior.

Exterior Rose	Lever/ Knob	Handing	Finish
1420	41	L	CP

## Full Set

Exterior Rose	Interior Rose	Lever/ Knob	Handing	Finish
1420	1421	41	L	CP

Exterior Rose Type	
Exterior Rose	1420
Exterior Blank Rose	1422
Exterior Fixed Rose	1424

Interior Rose Type	
Interior Rose	1421
Interior Blank Rose	1423
Interior Fixed Rose	1425

Lever/Knob Type		
20	32	44
45	55	55A
60	65	66
67	71	78
79	79B	83
97		

AS1428.1 Compliant Levers		
59	76	85*
70	77	90
74	80	92

Handed Levers		
41	53	61

\* Lever 85 is not available in CP

Handing	
Right Handed	R
Left Handed	L

NB: Omit if non-handed

Finish	
Satin Chrome Brushed	SC
Chrome Plate	CP
Polished Brass	PB
Polyester Powdercoat	PC*

Special Finishes	
Polished Brass Unlacquered	BU
Satin Brass	SB
Architectural Bronze	AZ
Architectural Bronze Unlacquered	AU
Antique Copper	AC
Oil Rubbed Bronze	ORB

\* For the powdercoat color range, please see the Dulux Powdercoat Range at the end of the plate furniture catalogue section.

# 1420 Symphony Series Ordering Procedure

## Selector Series Escutcheon Kits

Designed for use with Selector Mortice Locks only, all escutcheon kits are supplied with two M4 65mm stainless steel screws to allow for through fix installation.

Sample part number 1426/9NLSC is made up of several sections. The description of this part number is a left-handed oval cylinder and disabled accessible turnknob escutcheon kit.

Exterior Function	Interior Function	Privacy Indicator	Handing	Finish
1426	9	N	L	SC

Exterior Function	
Oval Cylinder	1426
Emergency Turn	1428
<b>Notes:</b> Order 1426/I if only one oval cylinder escutcheon is required. Wood screws will be supplied for surface mounting. 1428/6 Kit is not applicable.	

Interior Function	
Oval Cylinder	6
Oval Turnknob	7
Disabled Accessible Turnknob	9

Privacy Indicator	
Oval Cylinder	-
Non Indicating	N
Privacy Indicating	P
<b>Note:</b> Privacy indicator applies for both exterior and interior functions.	

Handing	
Right Handed	R
Left Handed	L
<b>Note:</b> Handing is based on the door, same as handing of a full set of rose door lever handles.  The sample part number shown above suits a left-handed door. This kit will be supplied with a right-handed disabled accessible turnknob, as the turnknob is intended to be used on the interior side of the door.  Only Kits with Disabled Accessible Turnknobs require handing.	

Finish	
Satin Chrome Brushed	SC
Chrome Plate	CP
Polished Brass	PB
Polyester Powdercoat	PC*

Special Finishes	
Polished Brass Unlacquered	BU
Satin Brass	SB
Architectural Bronze	AZ
Architectural Bronze Unlacquered	AU
Antique Copper	AC
Oil Rubbed Bronze	ORB

\* For the powdercoat color range, please see the Dulux Powdercoat Range at the end of the plate furniture catalogue section.



# 1420 Symphony Series Ordering Procedure

## Synergy Series Escutcheons

Designed for use with Synergy Series Mortice Locks. All escutcheons are supplied with wood screws to suit surface mounting on either side of the door.

Escutcheon Type	Fixing	Privacy Indicator	Handing	Finish
1429	I	P	L	SC

Escutcheon Type	
Oval Cylinder	1426
Oval Turnknob	1427
Emergency Turn	1428
Disabled Accessible Turnknob	1429*

**Note:**  
\*Cannot be used with Selector Mortice Locks, please order escutcheon kits if needed.

Fixing
Wood Screw
Surface Fixing I

Privacy Indicator
Oval Cylinder -
Non Indicating N
Privacy Indicating P

Handing	
Left Handed L	
Right Hand R	
NB: Only Disabled Accessible Turnknobs require handing	

Finish
Satin Chrome Brushed SC
Chrome Plate CP
Polished Brass PB
Polyester Powdercoat PC*

Special Finishes
Polished Brass Unlacquered BU
Satin Brass SB
Architectural Bronze AZ
Architectural Bronze Unlacquered AU
Antique Copper AC
Oil Rubbed Bronze ORB

\*For the powdercoat color range, please see the Dulux Powdercoat Range at the end of the plate furniture catalogue section.

# 1360 Series Brass Door Handles



Lockwood 1360 Series door furniture is manufactured from high quality solid brass material. The comprehensive lever range matched with ease of installation and compatibility with a wide range of Mortice Locks defines simple and reliable.

The accessory range includes cylinder escutcheons, emergency turns and disabled accessible turnknobs. For installers, the unique turn mechanism adjusts to suit the thickness of the door and removes the need to cut tailbars to length.

A full range of finishes from satin chrome through to a range of brass finishes and polyester powder coat provides all the options for matching to interior designs.

Proudly Australian Made at our factory at Oakleigh to the highest quality standards for strength, durability and corrosion resistance.

## Product Details

<b>Dimensions</b>	65.5mm diameter x 11.6mm.
<b>Handing</b>	A removable stop screw allows all symmetrically designed levers (e.g. Cadenza) to be handed on site. Levers of asymmetrical design (e.g. Veloce) cannot be reversed. Specify left or right handed when ordering.
<b>Materials</b>	All Lockwood roses and levers contained in the 1360 series are of solid brass construction.
<b>Fixing</b>	Roses are designed to fit back to back. If outside rose is specified with concealed fixing, then the inside rose must be visible fixed. Roses numbered 1360, 1362, and 1364 are concealed fixed, roses numbered 1361, 1363 and 1365 are visible fixed.
<b>Door Thickness</b>	Selector 3770 and Synergy 3770 Series: 32mm to 50mm Lockwood 5260 Latches: 33mm to 50mm
<b>Standard Finishes</b>	Satin Chrome Brushed (SC)
<b>Non-Standard Finishes</b>	Chrome Plate (CP) Polished Brass (PB) Polyester Powdercoat (PC)
<b>Special Finishes</b>	Architectural Bronze (AZ) Architectural Bronze Unlacquered (AU) Antique Copper (AC) Polished Brass Unlacquered (BU) Satin Brass (SB) Oil Rubbed Bronze (ORB)

## Standards and Compliance



Successfully tested up to 4 hours on fire door assemblies in accordance with Australian Standard AS1905.1 2005 - Part 1: Fire Resistant Doorsets.

**S3**

High security for maximum protection (AS4145.2:2008).

**D8**

Tested to AS 4145.2 2008 for Durability – Passing D8 500,000 cycles. Suitable for commercial applications.



Tested to AS 4145.2 2008 for Neutral Salt Spray – With SC Finish passing C10 1000 Hours - Extreme Corrosion Resistance. Suitable for coastal applications.



Disabled Accessible. AS1428.1 Compliant Levers and Turnknobs as indicated.



Australian Made

# 1360 Series Brass Door Handles

The 1360 Series rose furniture features a 65mm solid brass rose with diagonal screw fixings, concealed on the outside and visible on the inside.

**Supplied with:**

- 2 x M4 x 65mm Stainless Steel Screws (SP1220-119)
- 1 x Instructions (1220-221)

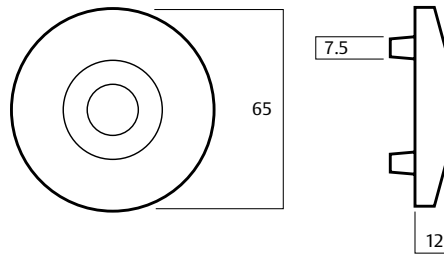

## AS1428.1 Compliant Levers

Overture - Lever 59	
<b>Length</b>	121mm
<b>Projection</b>	57.5mm
<b>Finger clearance</b>	38mm

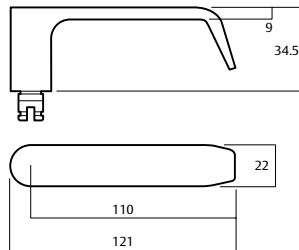

Lever 70	
<b>Length</b>	121mm
<b>Projection</b>	53mm
<b>Finger clearance</b>	37mm

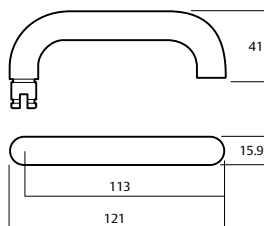

Ving - Lever 74	
<b>Length</b>	120mm
<b>Projection</b>	53mm
<b>Finger clearance</b>	45mm

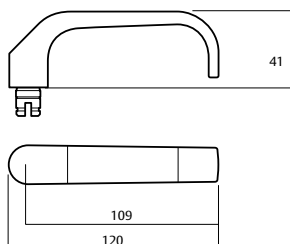

# 1360 Series Brass Door Handles

## AS1428.1 Compliant Levers

Lever 76	<b>NEW PRODUCT</b>
<b>Length</b>	125mm
<b>Projection</b>	50mm
<b>Finger clearance</b>	42mm

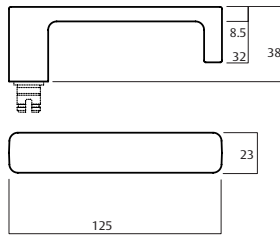

Lever 77	<b>NEW PRODUCT</b>
<b>Length</b>	121mm
<b>Projection</b>	51mm
<b>Finger clearance</b>	40.5mm

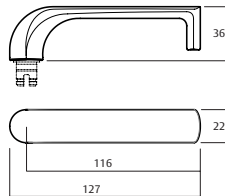

Lever 80	
<b>Length</b>	123mm
<b>Projection</b>	49mm
<b>Finger clearance</b>	40mm

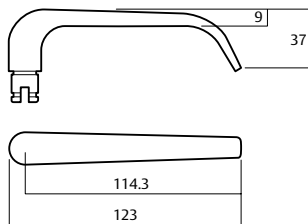

Lever 85	<b>NEW PRODUCT</b>
<b>Length</b>	125.5mm
<b>Projection</b>	51mm
<b>Finger clearance</b>	43.5mm

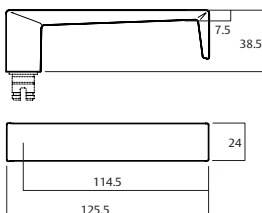

# 1360 Series Brass Door Handles

## AS1428.1 Compliant Levers

Lever 90	
<b>Length</b>	118.5mm
<b>Projection</b>	52mm
<b>Finger clearance</b>	45mm

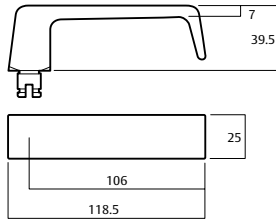

Lever 92	
<b>Length</b>	118.5mm
<b>Projection</b>	52mm
<b>Finger clearance</b>	45mm

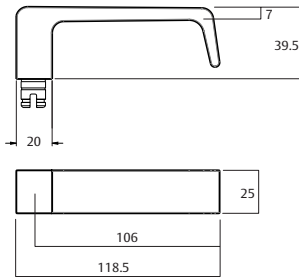

## Standard Knobs and Levers

20 Knob	
<b>Diameter</b>	50mm
<b>Projection</b>	73mm

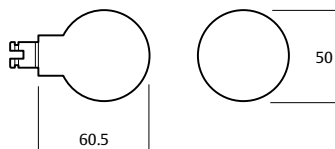

Lever 32	
<b>Length</b>	107.5mm
<b>Projection</b>	53mm
<b>Finger clearance</b>	35.5mm

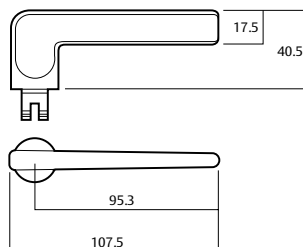

# 1360 Series Brass Door Handles

## Standard Knobs and Levers

### Intermezzo - Lever 41

<b>Length</b>	130mm
<b>Projection</b>	61.5mm
<b>Finger clearance</b>	40.5mm

\* Lever is an asymmetrical design and therefore must be handed.

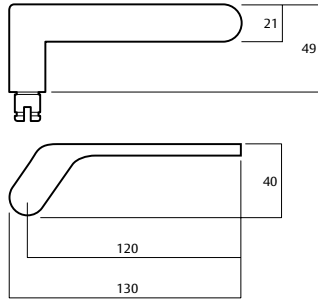

### Arpeggio - Lever 44

<b>Length</b>	125mm
<b>Projection</b>	59.5mm
<b>Finger clearance</b>	42mm

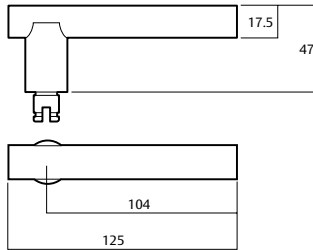

### Sonata - Lever 45

<b>Length</b>	117.5mm
<b>Projection</b>	57mm
<b>Finger clearance</b>	40mm

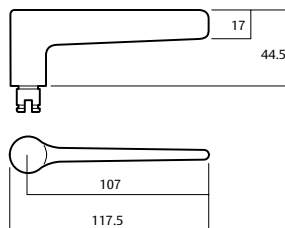

### Veloce - Lever 53

<b>Length</b>	123mm
<b>Projection</b>	73.5mm
<b>Finger clearance</b>	45mm

\*Lever is an asymmetrical design and therefore must be handed.

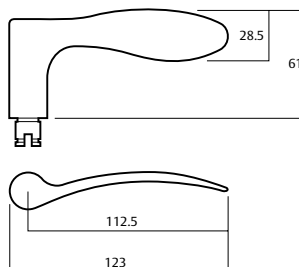

# 1360 Series Brass Door Handles

## Standard Knobs and Levers

### Lever 55

<b>Length</b>	124mm
<b>Projection</b>	62.5mm
<b>Finger clearance</b>	40.3mm

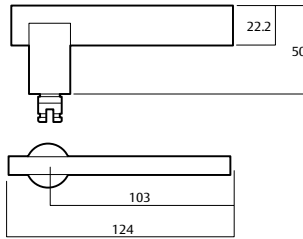

### Lever 55A

<b>Length</b>	115mm
<b>Projection</b>	62.5mm
<b>Finger clearance</b>	40.3mm

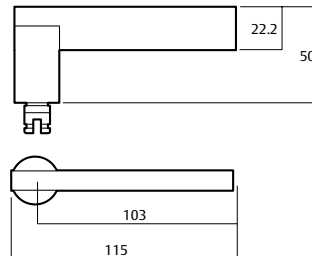

### Lever 60

<b>Length</b>	121mm
<b>Projection</b>	65mm
<b>Finger clearance</b>	54.2mm

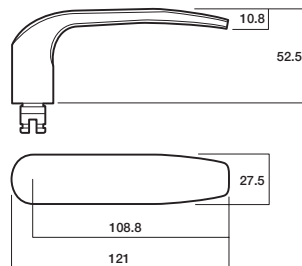

### Lever 61

<b>Length</b>	120mm
<b>Projection</b>	52.5mm
<b>Finger clearance</b>	25.5mm

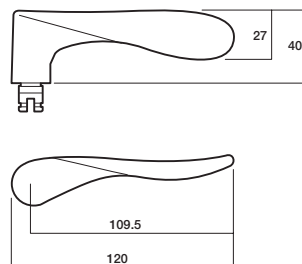

\*Lever is an asymmetrical design and therefore must be handed.

# 1360 Series Brass Door Handles

## Standard Knobs and Levers

Lever 65	<b>NEW PRODUCT</b>
<b>Length</b>	121mm
<b>Projection</b>	51mm
<b>Finger clearance</b>	43.5mm

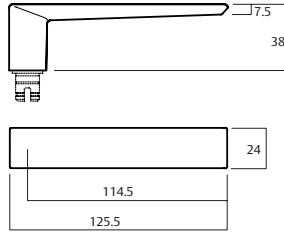

Lever 66	<b>NEW PRODUCT</b>
<b>Length</b>	125mm
<b>Projection</b>	50mm
<b>Finger clearance</b>	42mm

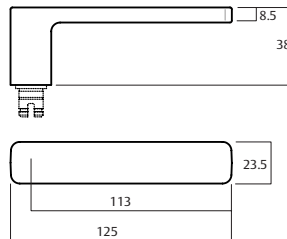

Lever 67	<b>NEW PRODUCT</b>
<b>Length</b>	127mm
<b>Projection</b>	48.5mm
<b>Finger clearance</b>	40.5mm

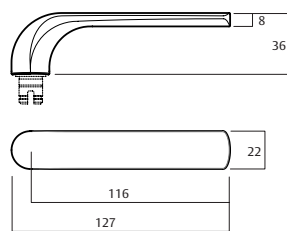

Tempo - Lever 71	
<b>Length</b>	118mm
<b>Projection</b>	62mm
<b>Finger clearance</b>	44.5mm

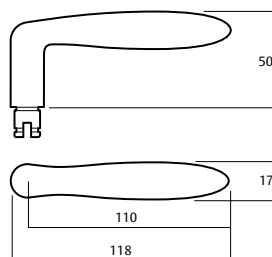



# 1360 Series Brass Door Handles

## Standard Knobs and Levers

### Cadenza - Lever 78

<b>Length</b>	118mm
<b>Projection</b>	52mm
<b>Finger clearance</b>	30mm

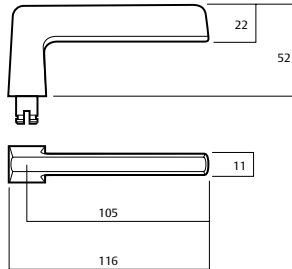

### Tenor - Lever 79

<b>Length</b>	124mm
<b>Projection</b>	50.5mm
<b>Finger clearance</b>	40.5mm

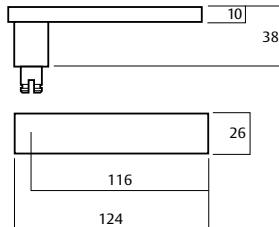

### Lever 79B

<b>Length</b>	118mm
<b>Projection</b>	50.5mm
<b>Finger clearance</b>	40.5mm

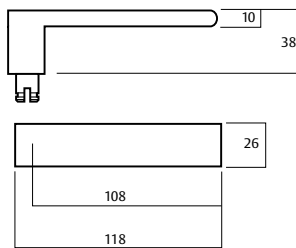

### Lever 83

<b>Length</b>	112mm
<b>Projection</b>	62mm
<b>Finger clearance</b>	33.5mm

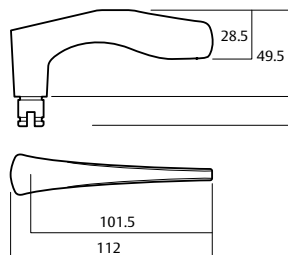

# 1360 Series Brass Door Handles

## Standard Knobs and Levers

### Chorus Line - Lever 97

<b>Length</b>	120mm
<b>Projection</b>	50.5mm
<b>Finger clearance</b>	34.6mm

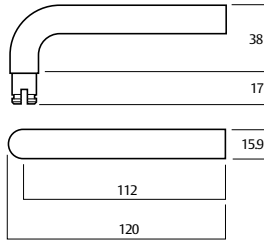

# 1360 Series Through Fix Escutcheon Kits

Designed for use with **Selector** Series Mortice Locks **only**, supplied with two M4 64mm stainless screws for through fix installation.

## Double Oval Cylinder Escutcheons Kit

**Part Number** 1366/6

### Escutcheons supplied

**Outside:** Oval Cylinder Escutcheon

**Inside:** Oval Cylinder Escutcheon

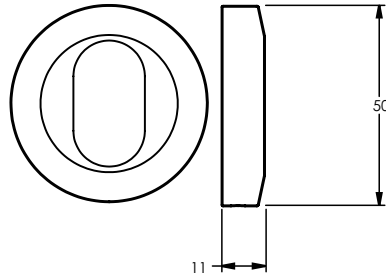

Outside

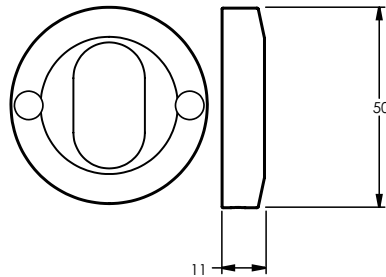

Inside

## Oval Cylinder and Turnknob Escutcheons Kit

**Part Number** 1366/7N

### Escutcheons supplied

**Outside:** Oval Cylinder Escutcheon

**Inside:** Turnknob Escutcheon

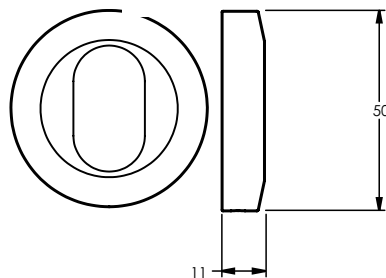

Outside

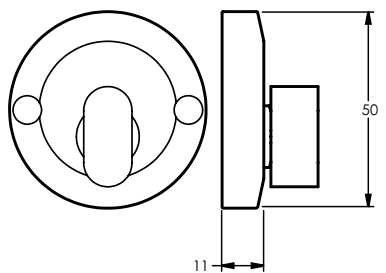

Inside

# 1360 Series Through Fix Escutcheon Kits

## Privacy Indicating Emergency Turn and Disabled Accessible Turnknob Escutcheons Kit

**Part Number** 1368/9P

### Escutcheons supplied

**Outside:** Privacy Indicating Emergency Turn Escutcheon

**Inside:** Privacy Indicating Disabled Accessible Turnknob Escutcheon

**Note:** Kits with Disabled Accessible Turnknobs require handing.

Handing is based on the door, same as handing of a full set of rose door lever handles.

A left-handed escutcheon kit suits a left-handed door and will be supplied with a right-handed disabled accessible turnknob, as this turnknob is intended to be used on the interior side of the door.

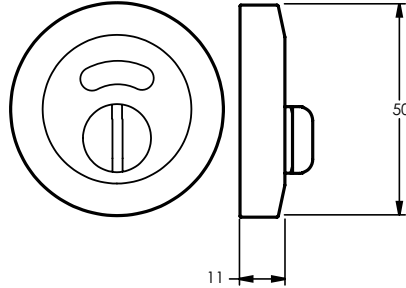

Outside

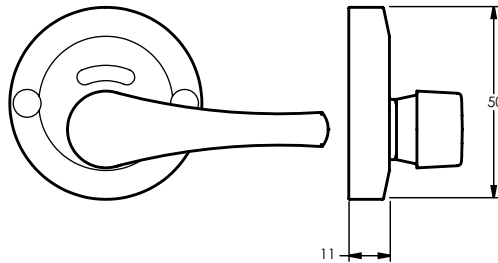

Inside

### HAND OF DOOR ACCORDING TO ENGLISH PRACTICE

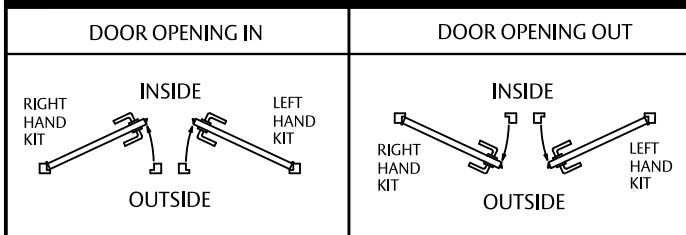

**Note:**

Common kit configurations are shown, for other kit variations please refer to the ordering procedure at the end of this section.

# 1360 Series Cylinder & Turn Escutcheons

Designed for use with **Synergy** Series Mortice Locks with surface mount screw fixings. The cylinder escutcheon features concealed fixing via a grub screw.

## Oval Cylinder Escutcheon

**Part Number** 1366/E

### Supplied with

- 2 x M4 x 65mm Stainless Steel Screws (SP1220-119)
- 1 x Allen Key (SP1366-14)
- 1 x Grub Screw M4 x 8mm (SPV0272 PBK)

(Replaces 1366)

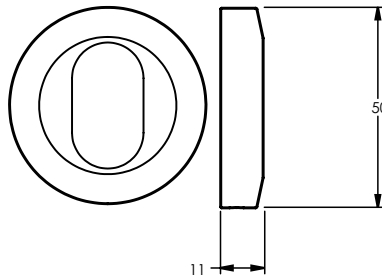

## Turnknob Escutcheon

**Part Number** 1367/IN

### Supplied with

- 2 x Short & 2 x Medium Wood Screws (SP1226-219)
- 1 x Short, Medium & Long Tail Bars and Spring (SP1227-219)
- 1 x Flat Tail Bar & Split Pin (SP1227-319)
- 1 x Instructions (1220-321)

(Replaces 1367)

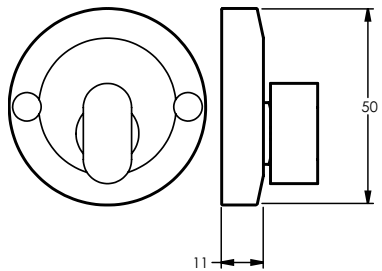

## Privacy Indicating Turnknob Escutcheon

**Part Number** 1367/IP

### Supplied with

- 2 x Short & 2 x Medium Wood Screws (SP1226-219)
- 1 x Short, Medium & Long Tail Bars and Spring (SP1227-219)
- 1 x Flat Tail Bar & Split Pin (SP1227-319)
- 1 x Instructions (1220-321)

(Replaces 1367P)

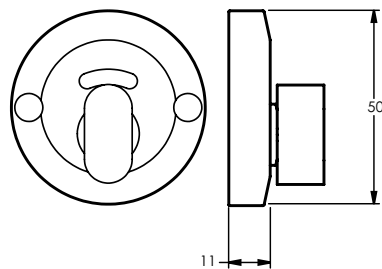

## Emergency Turn Escutcheon

**Part Number** 1368/IN

### Supplied with

- 2 x Short & 2 x Medium Wood Screws (SP1226-219)
- 1 x Emergency Tail Bar (SP1227-119)

(Replaces 1368)

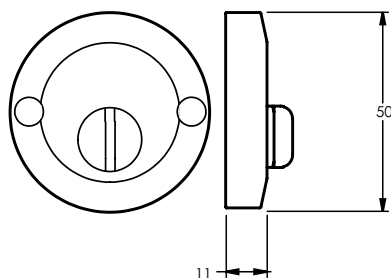

# 1360 Series Cylinder & Turn Escutcheons

## Privacy Indicating Emergency Turn Escutcheon

**Part Number** 1368/IP

### Supplied with

2 x Short & 2 x Medium Wood Screws (SP1226-219)  
1 x Emergency Tail Bar (SP1227-119)

(Replaces 1368P)

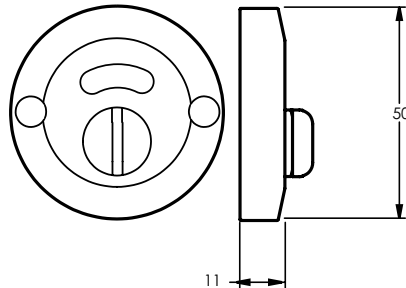

## Disabled Accessible Turnknob

**Part Number** 1369/IN

### Supplied with

2 x Short & 2 x Medium Wood Screws (SP1226-219)  
1 x Short, Medium & Long Tail Bars and Spring (SP1227-219)  
1 x Instructions (1220-321)

**Note:** Specify handing.

(Replaces 1367DT)

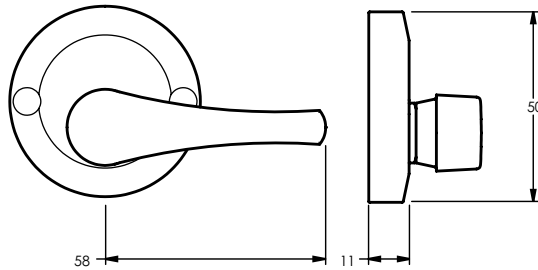

## Disabled Accessible Privacy Indicating Turnknob

**Part Number** 1369/IP

### Supplied with

2 x Short & 2 x Medium Wood Screws (SP1226-219)  
1 x Short, Medium & Long Tail Bars and Spring (SP1227-219)  
1 x Instructions (1220-321)

**Note:** Specify handing.

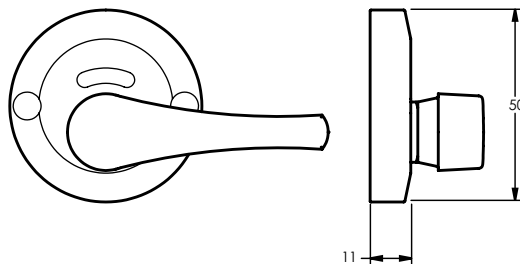

# 1360 Series Ordering Procedure

## Ordering Procedure

Sample part number 1360/41LCP is made up of several sections. Choose your product by selecting an option from each section.

## Half Set

**Note:** Choose one rose only, exterior or interior.

Exterior Rose	Lever/ Knob	Handing	Finish
1360	41	L	CP

## Full Set

Exterior Rose	Interior Rose	Lever/ Knob	Handing	Finish
1360	1361	41	L	CP

Exterior Rose Type	
Exterior Rose	1360
Exterior Blank Rose	1362
Exterior Fixed Rose	1364

Interior Rose Type	
Interior Rose	1361
Interior Blank Rose	1363
Interior Fixed Rose	1365

Lever/Knob Type		
20	32	44
45	55	55A
60	65	66
67	71	78
79	79B	83
97		

AS1428.1 Compliant Levers		
59	76	85*
70	77	90
74	80	92

Handed Levers		
41	53	61

\* Lever 85 is not available in CP

Handing	
Right Handed	R
Left Handed	L
NB: Omit if non-handed	

Finish	
Satin Chrome Brushed	SC
Chrome Plate	CP
Polished Brass	PB
Polyester Powdercoat	PC*

Non - Standard Finishes	
Polished Brass Unlacquered	BU
Satin Brass	SB
Architectural Bronze	AZ
Architectural Bronze Unlacquered	AU
Antique Copper	AC
Oil Rubbed Bronze	ORB

\* For the powdercoat color range, please see the Dulux Powdercoat Range at the end of the plate furniture catalogue section.

# 1360 Series Ordering Procedure

## Selector Series Escutcheon Kits

Designed for use with Selector Mortice Locks only, all escutcheon kits are supplied with two M4 65mm stainless steel screws to allow for through fix installation.

Sample part number 1366/9NLSC is made up of several sections. The description of this part number is a left-handed oval cylinder and disabled accessible turnknob escutcheon kit.

Exterior Function	Interior Function	Privacy Indicator	Handing	Finish
1366	9	N	L	SC

Exterior Function	
Oval Cylinder	1366
Emergency Turn	1368

**Notes:**

Order 1366/E if only one oval cylinder escutcheon is required. A grub screw will be supplied to allow for concealed fixing.

1368/6 Kit is not applicable.

Interior Function	
Oval Cylinder	6
Oval Turnknob	7
Disabled Accessible Turnknob	9

Privacy Indicator	
Oval Cylinder	-
Non Indicating	N
Privacy Indicating	P

**Note:**  
Privacy indicator applies for both exterior and interior functions.

Handing	
Right Handed	R
Left Handed	L

**Note:**

Handing is based on the door, same as handing of a full set of rose door lever handles.

The sample part number shown above suits a left-handed door. This kit will be supplied with a right-handed disabled accessible turnknob, as the turnknob is intended to be used on the interior side of the door.

Only Kits with Disabled Accessible Turnknobs require handing.

Finish	
Satin Chrome Brushed	SC
Chrome Plate	CP
Polished Brass	PB
Polyester Powdercoat	PC*

### Non - Standard Finishes

Polished Brass Unlacquered	BU
Satin Brass	SB
Architectural Bronze	AZ
Architectural Bronze Unlacquered	AU
Antique Copper	AC
Oil Rubbed Bronze	ORB

\* For the powdercoat color range, please see the Dulux Powdercoat Range at the end of the plate furniture catalogue section.



# 1360 Series Ordering Procedure

## Synergy Series Escutcheons

Designed for use with Synergy Series Mortice Locks. All escutcheons are supplied with wood screws to suit surface mounting on either side of the door.

Escutcheon Type	Fixing	Privacy Indicator	Handing	Finish
1369	I	P	L	SC

Escutcheon Type	
Oval Cylinder	1366
Oval Turn	1367
Emergency Turn	1368
Disabled Accessible Turn	1369*

**Note:**  
\*Cannot be used with Selector Mortice Locks, please order escutcheon kits if needed.

Fixing	
Wood Screw Surface Fixing	I
Grub Screw Concealed Fixing	E*

**Note:**  
\*Only applicable when ordering with 1366 Oval Cylinder Escutcheon. The 1366/E will be supplied with a grub screw to allow for concealed fixing.

Privacy Indicator	
Oval Cylinder	-
Non Indicating	N
Privacy Indicating	P

Handing	
Left Handed	L
Right Hand	R

NB: Only Disabled Accessible Turnknobs require handing

Finish	
Satin Chrome Brushed	SC
Chrome Plate	CP
Polished Brass	PB
Polyester Powdercoat	PC*

Special Finishes	
Polished Brass Unlacquered	BU
Satin Brass	SB
Architectural Bronze	AZ
Architectural Bronze Unlacquered	AU
Antique Copper	AC
Oil Rubbed Bronze	ORB

\* For the powdercoat color range, please see the Dulux Powdercoat Range at the end of the plate furniture catalogue section.

# 1370 Series Brass Door Handles



Lockwood 1370 Series door furniture is manufactured from high quality solid brass material. The comprehensive lever range matched with ease of installation and compatibility with a wide range of Mortice Locks defines simple and reliable.

The accessory range includes cylinder escutcheons, emergency turns and disabled accessible turnknobs. For installers, the unique turn mechanism adjusts to suit the thickness of the door and removes the need to cut tailbars to length.

A full range of finishes from satin chrome through to a range of brass finishes and polyester powder coat provides all the options for matching to interior designs.

Proudly Australian Made at our factory at Oakleigh to the highest quality standards for strength, durability and corrosion resistance.

## Product Details

<b>Dimensions</b>	62.5mm diameter x 11.6mm.
<b>Materials</b>	All Lockwood roses and levers contained in the 1370 series are of solid brass construction.
<b>Fixing</b>	Roses are designed to fit back to back. If outside rose is specified with concealed fixing, then the inside rose must be visible fixed. Roses numbered 1370, 1372 and 1374 are concealed fixed, roses numbered 1371, 1373 and 1375 are visible fixed.
<b>Door Thickness</b>	Selector 3770 and Synergy 3570 Series: 32mm to 50mm Lockwood 5260 Latches: 33mm to 50mm
<b>Finishes Standard</b>	Satin Chrome Brushed (SC)
<b>Non-Standard Finishes</b>	Chrome Plate (CP) Polished Brass (PB) Polyester Powdercoat (PC)
<b>Special Finishes</b>	Architectural Bronze (AZ) Architectural Bronze Unlacquered (AU) Antique Copper (AC) Polished Brass Unlacquered (BU) Satin Brass (SB) Oil Rubbed Bronze (ORB)

## Standards and Compliance



Successfully tested up to 4 hours on fire door assemblies in accordance with Australian Standard AS1905.1 2005 - Part 1: Fire Resistant Doorsets.

**S3**

High security for maximum protection (AS4145.2:2008).

**D8**

Tested to AS 4145.2 2008 for Durability – Passing D8 500,000 cycles. Suitable for commercial applications.



Tested to AS 4145.2 2008 for Neutral Salt Spray – With SC Finish passing C10 1000 Hours - Extreme Corrosion Resistance. Suitable for coastal applications.



Disabled Accessible. AS1428.1 Compliant Levers and Turnknobs as indicated.



Australian Made

# 1370 Series Brass Door Handles

The 1370 Series rose furniture features a 62mm solid brass rose with diagonal screw fixings, concealed on the outside and visible on the inside.

**Supplied with:**

- 2 x M4 x 65mm Stainless Steel Screws (SP1220-119)
- 1 x Instructions (1220-221)

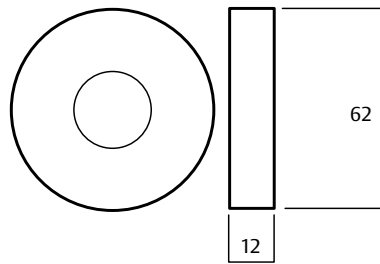

## AS1428.1 Compliant Levers

### Overture - Lever 59

<b>Length</b>	121mm
<b>Projection</b>	57.5mm
<b>Finger clearance</b>	38mm

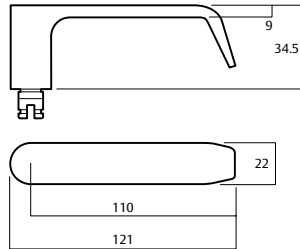

### Lever 70

<b>Length</b>	121mm
<b>Projection</b>	53mm
<b>Finger clearance</b>	37mm

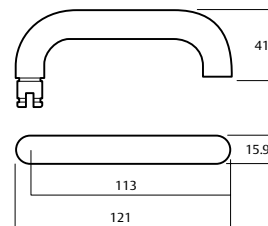

### Ving - Lever 74

<b>Length</b>	120mm
<b>Projection</b>	53mm
<b>Finger clearance</b>	45mm

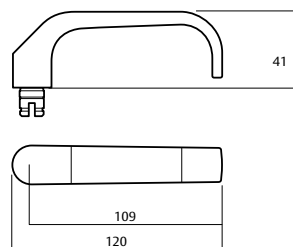

# 1370 Series Brass Door Handles

## AS1428.1 Compliant Levers

Lever 76	<b>NEW PRODUCT</b>
<b>Length</b>	125mm
<b>Projection</b>	50mm
<b>Finger clearance</b>	42mm

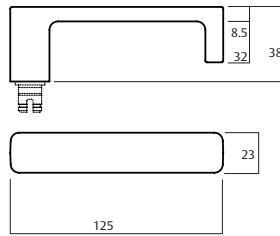

Lever 77	<b>NEW PRODUCT</b>
<b>Length</b>	121mm
<b>Projection</b>	51mm
<b>Finger clearance</b>	40.5mm

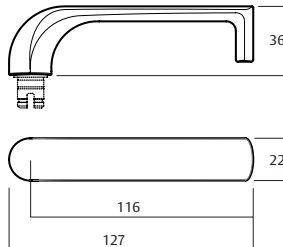

Lever 80	<b>NEW PRODUCT</b>
<b>Length</b>	123mm
<b>Projection</b>	49mm
<b>Finger clearance</b>	40mm

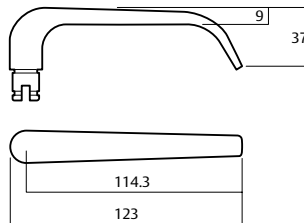

Lever 85	<b>NEW PRODUCT</b>
<b>Length</b>	125.5mm
<b>Projection</b>	51mm
<b>Finger clearance</b>	43.5mm

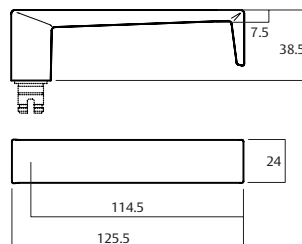

# 1370 Series Brass Door Handles

## AS1428.1 Compliant Levers

Lever 90	
<b>Length</b>	118.5mm
<b>Projection</b>	52mm
<b>Finger clearance</b>	45mm

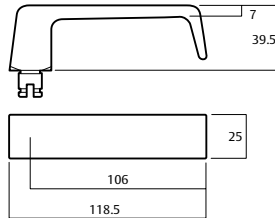

Lever 92	
<b>Length</b>	118.5mm
<b>Projection</b>	52mm
<b>Finger clearance</b>	45mm

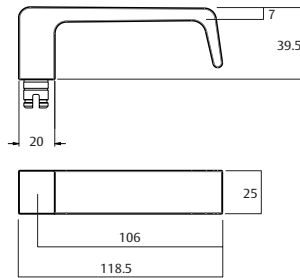

## Standard Knobs and Levers

20 Knob	
<b>Diameter</b>	50mm
<b>Projection</b>	73mm

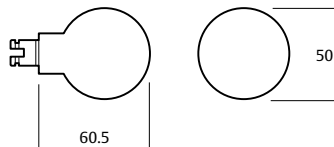

Lever 32	
<b>Length</b>	107.5mm
<b>Projection</b>	53mm
<b>Finger clearance</b>	35.5mm

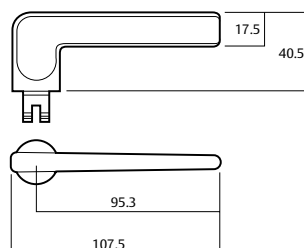

# 1370 Series Brass Door Handles

## Standard Knobs and Levers

### Intermezzo - Lever 41

<b>Length</b>	130mm
<b>Projection</b>	61.5mm
<b>Finger clearance</b>	40.5mm

\* Lever is an asymmetrical design and therefore must be handed.

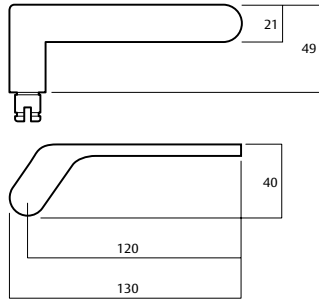

### Arpeggio - Lever 44

<b>Length</b>	125mm
<b>Projection</b>	59.5mm
<b>Finger clearance</b>	42mm

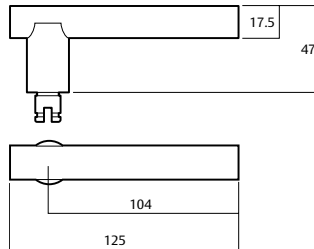

### Sonata - Lever 45

<b>Length</b>	117.5mm
<b>Projection</b>	57mm
<b>Finger clearance</b>	40mm

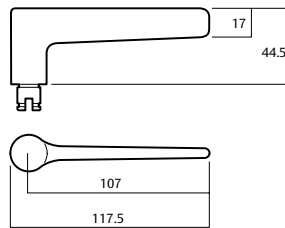

### Veloce - Lever 53

<b>Length</b>	123mm
<b>Projection</b>	73.5mm
<b>Finger clearance</b>	45mm

\*Lever is an asymmetrical design and therefore must be handed.

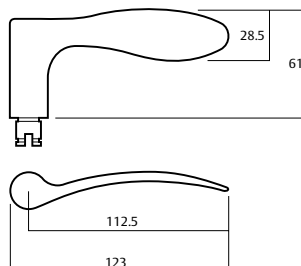

# 1370 Series Brass Door Handles

## Standard Knobs and Levers

### Lever 55

<b>Length</b>	124mm
<b>Projection</b>	62.5mm
<b>Finger clearance</b>	40.3mm

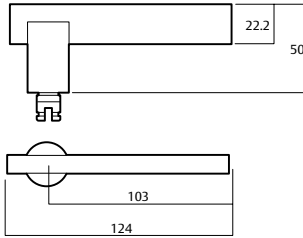

### Lever 55A

<b>Length</b>	115mm
<b>Projection</b>	62.5mm
<b>Finger clearance</b>	40.3mm

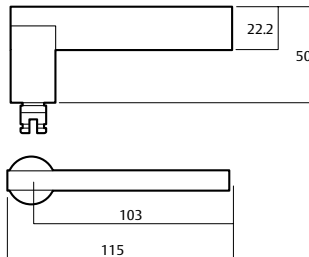

### Lever 60

<b>Length</b>	121mm
<b>Projection</b>	65mm
<b>Finger clearance</b>	54.2mm

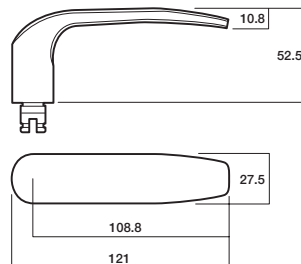

### Lever 61\*

<b>Length</b>	120mm
<b>Projection</b>	52.5mm
<b>Finger clearance</b>	25.5mm

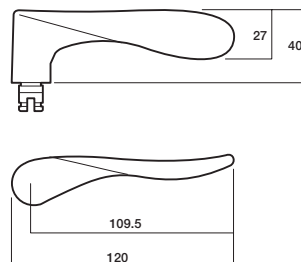

\*Lever is an asymmetrical design and therefore must be handed.

# 1370 Series Brass Door Handles

## Standard Knobs and Levers

Lever 65	<b>NEW PRODUCT</b>
<b>Length</b>	121mm
<b>Projection</b>	51mm
<b>Finger clearance</b>	43.5mm

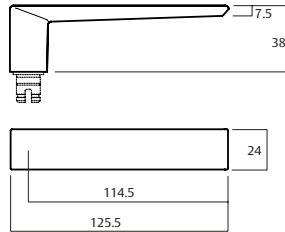

Lever 66	<b>NEW PRODUCT</b>
<b>Length</b>	125mm
<b>Projection</b>	50mm
<b>Finger clearance</b>	42mm

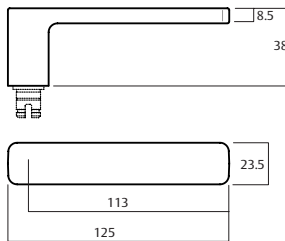

Lever 67	<b>NEW PRODUCT</b>
<b>Length</b>	127mm
<b>Projection</b>	48.5mm
<b>Finger clearance</b>	40.5mm

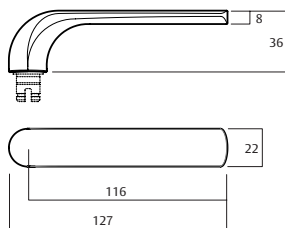

Tempo - Lever 71	
<b>Length</b>	118mm
<b>Projection</b>	62mm
<b>Finger clearance</b>	44.5mm

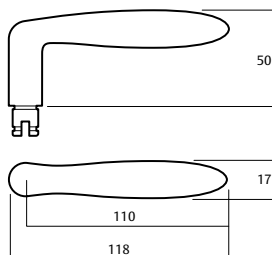



# 1370 Series Brass Door Handles

## Standard Knobs and Levers

### Cadenza - Lever 78

<b>Length</b>	118mm
<b>Projection</b>	52mm
<b>Finger clearance</b>	30mm

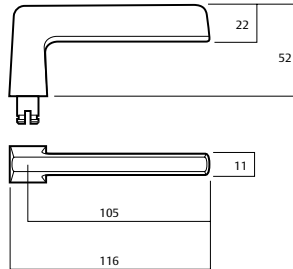

### Tenor - Lever 79

<b>Length</b>	124mm
<b>Projection</b>	50.5mm
<b>Finger clearance</b>	40.5mm

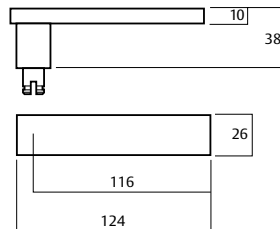

### Lever 79B

<b>Length</b>	118mm
<b>Projection</b>	50.5mm
<b>Finger clearance</b>	40.5mm

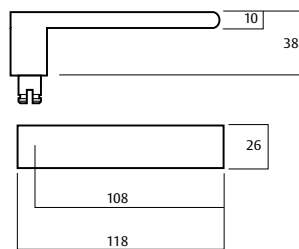

### Lever 83

<b>Length</b>	112mm
<b>Projection</b>	62mm
<b>Finger clearance</b>	33.5mm

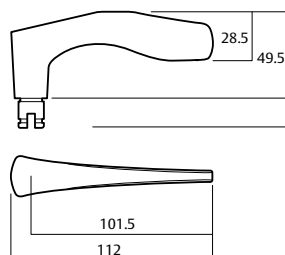

# 1370 Series Brass Door Handles

## Standard Knobs and Levers

### Chorus Line - Lever 97

<b>Length</b>	120mm
<b>Projection</b>	50.5mm
<b>Finger clearance</b>	34.6mm

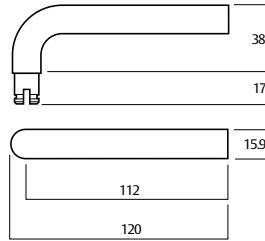

# 1370 Series Through Fix Escutcheon Kits

Designed for use with **Selector** Series Mortice Locks **only**, supplied with two M4 64mm stainless screws for through fix installation.

## Double Oval Cylinder Escutcheons Kit

**Part Number** 1376/6

### Escutcheons supplied

**Outside:** Oval Cylinder Escutcheon

**Inside:** Oval Cylinder Escutcheon

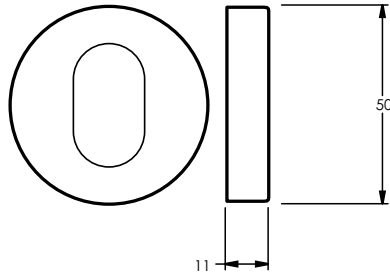

Outside

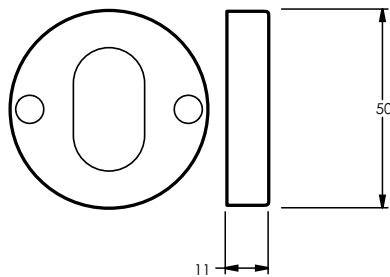

Inside

## Oval Cylinder and Turnknob Escutcheons Kit

**Part Number** 1376/7N

### Escutcheons supplied

**Outside:** Oval Cylinder Escutcheon

**Inside:** Turnknob Escutcheon

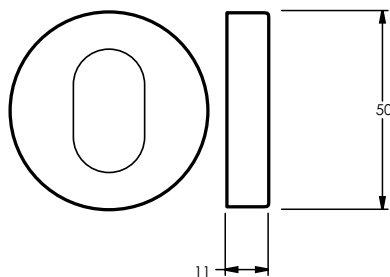

Outside

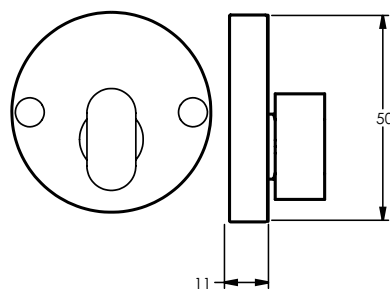

Inside

# 1370 Series Through Fix Escutcheon Kits

## Privacy Indicating Emergency Turn and Disabled Accessible Turnknob Escutcheons Kit

**Part Number** 1378/9P

### Escutcheons supplied

**Outside:** Privacy Indicating Emergency Turn Escutcheon

**Inside:** Privacy Indicating Disabled Accessible Turnknob Escutcheon

**Note:** Kits with Disabled Accessible Turnknobs require handing.

Handing is based on the door, same as handing of a full set of rose door lever handles.

A left-handed escutcheon kit suits a left-handed door and will be supplied with a right-handed disabled accessible turnknob, as this turnknob is intended to be used on the interior side of the door.

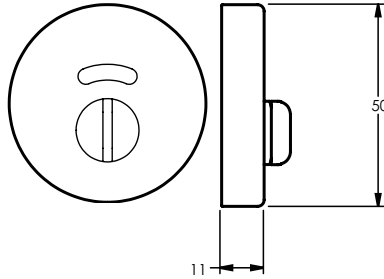

Outside

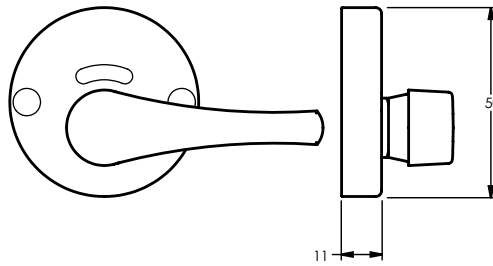

Inside

### HAND OF DOOR ACCORDING TO ENGLISH PRACTICE

DOOR OPENING IN		DOOR OPENING OUT	
INSIDE	INSIDE	INSIDE	INSIDE
RIGHT HAND KIT	LEFT HAND KIT	RIGHT HAND KIT	LEFT HAND KIT
OUTSIDE	OUTSIDE	OUTSIDE	OUTSIDE

**Note:** Common kit configurations are shown, for other kit variations please refer to the ordering procedure at the end of this section.

# 1370 Series Cylinder & Turn Escutcheons

Designed for use with **Synergy** Series Mortice Locks with surface mount screw fixings. The cylinder escutcheon features concealed fixing via a grub screw.

## Oval Cylinder Escutcheon

**Part Number** 1376/E

### Supplied with

- 2 x M4 x 65mm Stainless Steel Screws (SP1220-119)
- 1 x Allen Key (SP1366-14)
- 1 x Grub Screw M4 x 8mm (SPV0272 PBK)

(Replaces 1376)

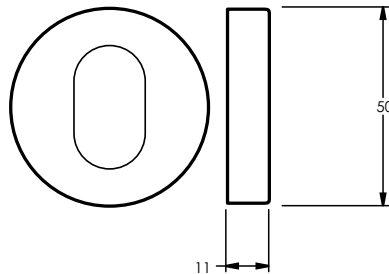

## Turnknob Escutcheon

**Part Number** 1377/IN

### Supplied with

- 2 x Short & 2 x Medium Wood Screws (SP1226-219)
- 1 x Short, Medium & Long Tail Bars and Spring (SP1227-219)
- 1 x Flat Tail Bar & Split Pin (SP1227-319)
- 1 x Instructions (1220-321)

(Replaces 1377)

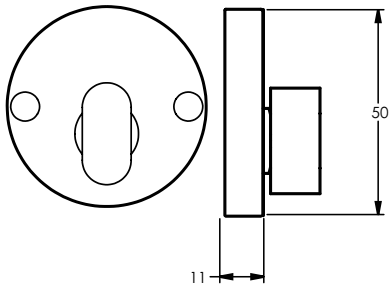

## Privacy Indicating Turnknob Escutcheon

**Part Number** 1377/IP

### Supplied with

- 2 x Short & 2 x Medium Wood Screws (SP1226-219)
- 1 x Short, Medium & Long Tail Bars and Spring (SP1227-219)
- 1 x Flat Tail Bar & Split Pin (SP1227-319)
- 1 x Instructions (1220-321)

(Replaces 1377P)

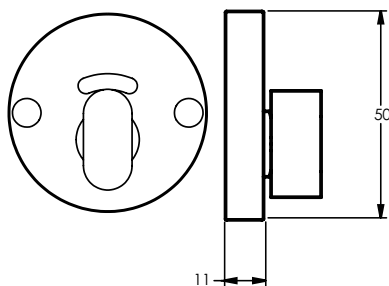

## Emergency Turn Escutcheon

**Part Number** 1378/IN

### Supplied with

- 2 x Short & 2 x Medium Wood Screws (SP1226-219)
- 1 x Emergency Tail Bar (SP1227-119)

(Replaces 1378)

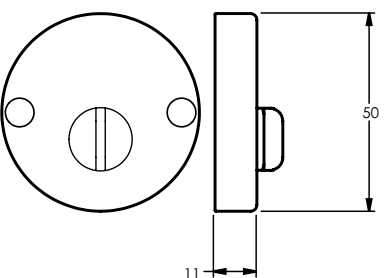

# 1370 Series Cylinder & Turn Escutcheons

## Privacy Indicating Emergency Turn Escutcheon

**Part Number** 1378/IP

### Supplied with

2 x Short & 2 x Medium Wood Screws (SP1226-219)  
1 x Emergency Tail Bar (SP1227-119)

(Replaces 1378P)

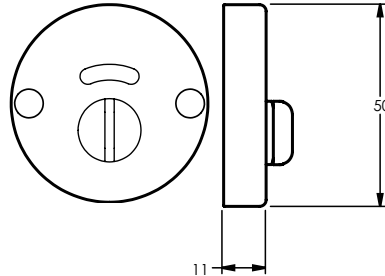

## Disabled Accessible Turnknob

**Part Number** 1379/IN

### Supplied with

2 x Short & 2 x Medium Wood Screws (SP1226-219)  
1 x Short, Medium & Long Tail Bars and Spring (SP1227-219)  
1 x Instructions (1220-321)

**Note:** Specify handing

(Replaces 1377DT)

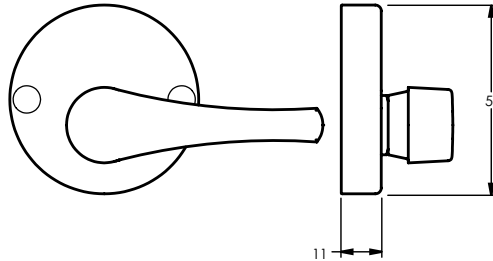

## Disabled Accessible Privacy Indicating Turnknob

**Part Number** 1379/IP

### Supplied with

2 x Short & 2 x Medium Wood Screws (SP1226-219)  
1 x Short, Medium & Long Tail Bars and Spring (SP1227-219)  
1 x Instructions (1220-321)

**Note:** Specify handing

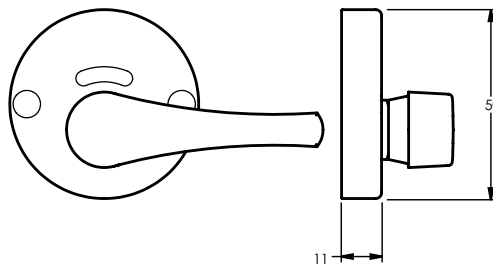

# 1370 Series Ordering Procedure

Sample part number 1370/1371/41LCP is made up of several sections. Choose your product by selecting an option from each section.

## Half Set

**Note:** Choose one rose only, exterior or interior.

Exterior Rose	Lever/ Knob	Handing	Finish
1370	41	L	CP

## Full Set

Exterior Rose	Interior Rose	Lever/ Knob	Handing	Finish
1370	1371	41	L	CP

Exterior Rose Type	
Exterior Rose	1370
Exterior Blank Rose	1372
Exterior Fixed Rose	1374

Interior Rose Type	
Interior Rose	1371
Interior Blank Rose	1373
Interior Fixed Rose	1375

Lever/Knob Type		
20	32	44
45	55	55A
60	65	66
67	71	78
79	79B	83
97		

AS1428.1 Compliant Levers		
59	76	85*
70	77	90
74	80	92

Handed Levers		
41	53	61

\* Lever 85 is not available in CP

Handing	
Right Handed	R
Left Handed	L

NB: Omit if non-handed

Finish	
Satin Chrome Brushed	SC
Chrome Plate	CP
Polished Brass	PB
Polyester Powdercoat	PC*

Non - Standard Finishes	
Polished Brass Unlacquered	BU
Satin Brass	SB
Architectural Bronze	AZ
Architectural Bronze Unlacquered	AU
Antique Copper	AC
Oil Rubbed Bronze	ORB

\* For the powdercoat color range, please see the Dulux Powdercoat Range at the end of the plate furniture catalogue section.

# 1370 Series Ordering Procedure

## Selector Series Escutcheon Kits

Designed for use with Selector Mortice Locks only, all escutcheon kits are supplied with two M4 65mm stainless steel screws to allow for through fix installation.

Sample part number 1376/9NLSC is made up of several sections. The description of this part number is a left-handed oval cylinder and disabled accessible turnknob escutcheon kit.

Exterior Function	Interior Rose	Privacy Indicator	Handing	Finish
1376	9	N	L	SC

Exterior Function	
Oval Cylinder	1376
Emergency Turn	1378

**Notes:**  
Order 1376/E if only one oval cylinder escutcheon is required. A grub screw will be supplied to allow for concealed fixing.

1378/6 Kit is not applicable.

Interior Function	
Oval Cylinder	6
Oval Turnknob	7
Disabled Accessible Turnknob	9

Privacy Indicator	
Oval Cylinder	-
Non Indicating	N
Privacy Indicating	P

**Note:**  
Privacy indicator applies for both exterior and interior functions.

Handing	
Right Handed	R
Left Handed	L

**Note:**  
Handing is based on the door, same as handing of a full set of rose door lever handles.

The sample part number shown above suits a left-handed door. This kit will be supplied with a right-handed disabled accessible turnknob, as the turnknob is intended to be used on the interior side of the door.

Only Kits with Disabled Accessible Turnknobs require handing.

Finish	
Satin Chrome Brushed	SC
Chrome Plate	CP
Polished Brass	PB
Polyester Powdercoat	PC*

Special Finishes	
Polished Brass Unlacquered	BU
Satin Brass	SB
Architectural Bronze	AZ
Architectural Bronze Unlacquered	AU
Antique Copper	AC
Oil Rubbed Bronze	ORB

\* For the powdercoat color range, please see the Dulux Powdercoat Range at the end of the plate furniture catalogue section.



# 1370 Series Ordering Procedure

## Synergy Series Escutcheons

Designed for use with Synergy Series Mortice Locks. All escutcheons are supplied with wood screws to suit surface mounting on either side of the door.

Escutcheon Type	Fixing	Privacy Indicator	Handing	Finish
1379	I	P	L	SC

Escutcheon Type	
Oval Cylinder	1376
Oval Turn	1377
Emergency Turn	1378
Disabled Accessible Turn	1379*

**Note:**  
\*Cannot be used with Selector Mortice Locks, please order escutcheon kits if needed.

Fixing	
Wood Screw Surface Fixing	I
Grub Screw Concealed Fixing	E*

**Note:**  
\*Only applicable when ordering with 1376 Oval Cylinder Escutcheon. The 1376/E will be supplied with a grub screw to allow for concealed fixing.

Privacy Indicator	
Oval Cylinder	-
Non Indicating	N
Privacy Indicating	P

Handing	
Left Handed	L
Right Hand	R
NB: Only Disabled Accessible Turnknobs require handing	

Finish	
Satin Chrome Brushed	SC
Chrome Plate	CP
Polished Brass	PB
Polyester Powdercoat	PC*

Special Finishes	
Polished Brass Unlacquered	BU
Satin Brass	SB
Architectural Bronze	AZ
Architectural Bronze Unlacquered	AU
Antique Copper	AC
Oil Rubbed Bronze	ORB

\* For the powdercoat color range, please see the Dulux Powdercoat Range at the end of the plate furniture catalogue section.

# 260 Series Door Handles



The 260 Series door furniture has a 55mm round rose. Concealed fixed plates have studs with internal threads located on the rose, visible roses have corresponding countersunk holes and are fixed back to back through the door.

## Application

Designed for use with Lockwood 3770 and 3570 Series Mortice Latches and with 5260 Tubular Latches.

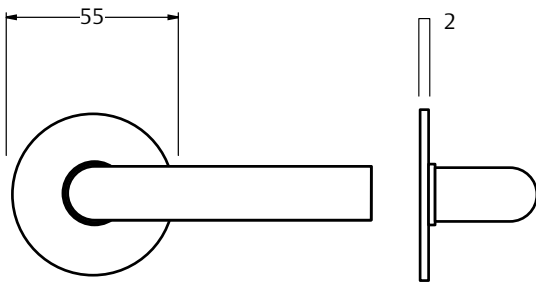



SS/Brass

## Product Details

<b>Dimensions</b>	Lever Rose
	55 x 3mm - aluminium 55 x 2mm - stainless steel and brass Escutcheon Rose
<b>Materials</b>	Aluminium, stainless steel or brass
	For use with 3570 Series Mortice Latches: Door thickness 35 to 45mm For use with 5260 Tubular Latches: Door thickness 37-45mm (Extended screws and packing plates available for installation on thicker and thinner doors.)
<b>Finishes Standard</b>	Stainless Steel (SS)
<b>Finishes Non Standard</b>	Polished Stainless Steel (PS) Powdercoat (PC)

## Standards and Compliance

	Fire Rated
<b>S3</b>	High security for maximum protection (AS4145.2:1993)
<b>D3</b>	High durability for maximum frequency usage
	Anti-Corrosion
	Disabled Access. Australian Standard (AS AS1428.1) Design for access and mobility.

# 260 Series Door Handle Functions

## Rose Furniture 55mm Diameter

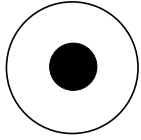

260 Operable

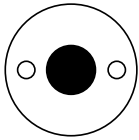

261 Operable

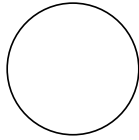

262 Blank

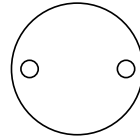

263 Blank

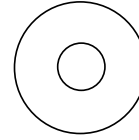

264 Fixed

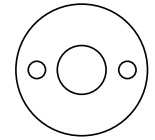

265 Fixed

## Escutcheon Furniture 50mm Diameter

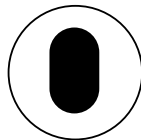

280

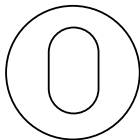

281

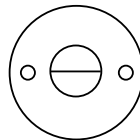

282

### Functions Legend

Cylinder Hole



Turnknob



Emergency Turn



# 260SQ Series Square Door Rose Door Handles





The 260SQ Series door furniture has a 55mm x 2mm square rose. Concealed fixed plates have studs with internal threads located on the rose, visible roses have corresponding countersunk holes and are fixed back to back through the door.

## Application

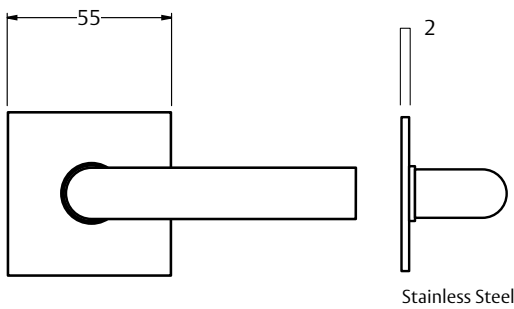
Designed for use with Lockwood 3770 and 3570 Series Mortice Latches and with 5260 Tubular Latches.



Product Details	
<b>Dimensions</b>	Lever Rose 55 x 2mm - stainless steel
	Escutcheon Rose 50 x 2mm - stainless steel
<b>Materials</b>	Stainless steel only
<b>Door Thickness</b>	For use with 3570 Series Mortice Latches: Door thickness 35 to 45mm
	For use with 5260 Tubular Latches: Door thickness 37-45mm (Extended screws and packing plates available for installation on thicker and thinner doors.)
<b>Finishes Standard</b>	Stainless Steel (SS)
Standards and Compliance	
	Fire Rated
<b>S3</b>	High security for maximum protection (AS4145.2:1993)
<b>D3</b>	High durability for maximum frequency usage
	Anti-Corrosion
	Disabled Access. Australian Standard (AS AS1428.1) Design for access and mobility.

# 260SQ Series Square Door Rose Door Handles

## Levers and Knob to Suit

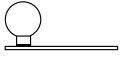

20\*1

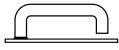

96

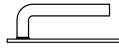

98

## Square Furniture 55 x 55mm

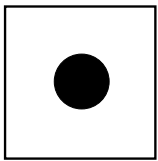

260 Operable

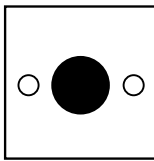

261 Operable



262 Blank

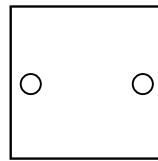

263 Blank

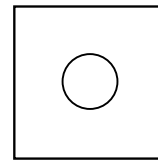

264 Fixed

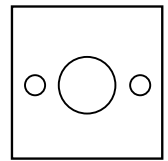

265 Fixed

## Square Escutcheon Furniture 50 x 50mm

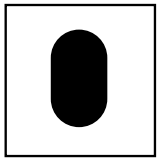

280SQ

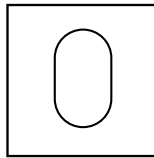

281SQ

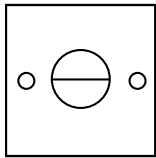

282SQ

### Functions Legend

Cylinder Hole



Turnknob



Emergency Turn



# 260 Series Ordering Procedure

## Ordering Procedure

Sample part number 260/261/SQ96SS is made up of several sections. Choose your product by selecting an option from each section.

## Half Set

For example:

Exterior Rose	Lever/ Knob	Handing	Finish
260	SQ	96	SS

**Note:** Choose one rose only, exterior or interior.

## 260 Series

Exterior Rose	Interior Rose	Rose Shape	Lever/ Knob	Handing	Finish
260	261	-	96	L	SS

### Exterior Rose Type

Exterior Rose	260
Exterior Blank Rose	262
Exterior Round Rose -Fixed Rose	264

### Interior Rose Type

Interior Rose	261
Interior Blank Rose	263
Interior Fixed Rose	265

### Rose Shape

Round	-
Square	SQ

### Lever/ Knob Type

Brass Levers		
32	44	45
55	55A	60
65	66	67
70	71	74
78	79	79B
80	83	90
92	97	

### AS1428.1 Compliant Levers

#### Stainless Steel Levers

96

#### Brass Levers

59      76      77  
85\*

### Handed Levers

#### Brass Levers

41      53      61

\* Lever 85 is not available in CP

### Handing

Left Handed	L
Right Handed	R

### Finish - 260 Series

Satin Stainless Steel	SS
Powdercoat	PC
Polished Stainless Steel	PS
Aluminium	NT
Polished Brass	PB

### Finish - 260SQ Series

Satin Stainless Steel	SS
-----------------------	----

# Ovation® Series Door Handles





The Lockwood Ovation Series offers a selection of stylish and durable investment cast and hollow stainless steel levers on round roses.

## Application

Suitable for use in commercial and residential buildings.

Designed and manufactured for use with Lockwood Selector 3770 and Synergy 3570 Series Mortice Locks and Tubular Latch.

Product Details	
<b>Dimensions</b>	55mm diameter x 12mm.
<b>Handing</b>	A removable stop screw allows all symmetrically designed levers to be handed on site.
<b>Materials</b>	304 stainless steel.
<b>Fixing</b>	Roses are designed to fit back to back and fixings are concealed by the use of a screw on outer rose.
<b>Door Thickness</b>	Selector 3770 and Synergy 3570 Series: 32mm to 45mm
<b>Finishes Standard</b>	Stainless Steel (SS).
<b>Privacy</b>	Privacy function for Ovation Rose Furniture is achieved using the 3290 privacy adaptor, which matches the diameter of the rose lever sets.

Standards and Compliance	
	Successfully tested up to 2 hours on fire door assemblies in accordance with Australian Standard AS1905.1 2005 - Part 1: Fire Resistant Doorsets.
	Anti-Corrosion.
	AS1428.1 Compliance The range includes AS1428.1 compliant levers and turns as shown.

# Ovation® Series Door Handles

## AS1428.1 Compliant Levers

### Lever S23

<b>Length</b>	125mm
<b>Projection</b>	60mm
<b>Finger Clearance</b>	43mm

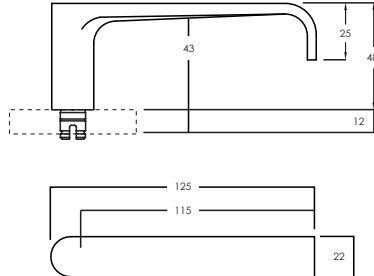

### Lever 96

<b>Length</b>	125.5mm
<b>Projection</b>	57mm
<b>Finger Clearance</b>	39.5mm

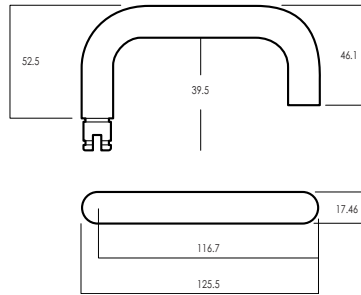

## Stand Hollow Levers

### Cuji® - Lever H08

<b>Length</b>	126mm
<b>Projection</b>	65mm
<b>Finger Clearance</b>	46mm

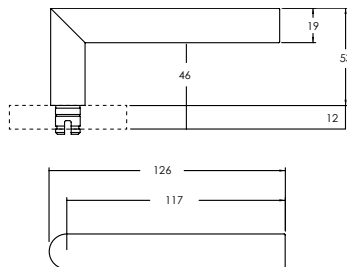

### Nusa® - Lever H20

<b>Length</b>	136mm
<b>Projection</b>	72mm
<b>Finger Clearance</b>	53mm

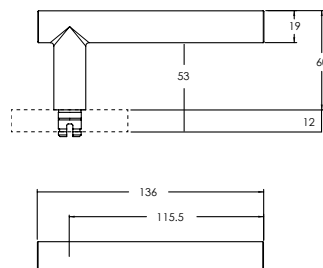



# Ovation® Series Door Handles

## Dema® - Lever H54

<b>Length</b>	135mm
<b>Projection</b>	64mm
<b>Finger Clearance</b>	45mm

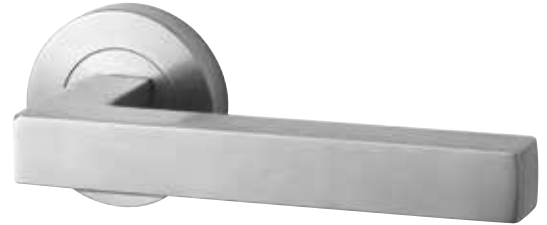
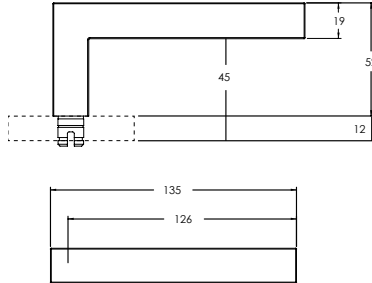

## Tulu® - Lever H11

<b>Length</b>	136mm
<b>Projection</b>	72mm
<b>Finger Clearance</b>	53mm

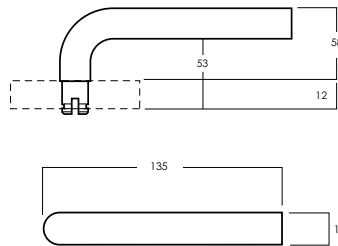

## Standard Solid Levers

### Aria® - Lever S27

<b>Length</b>	120mm
<b>Projection</b>	51mm
<b>Finger Clearance</b>	37mm

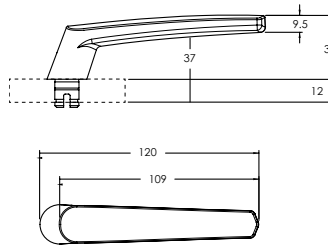

### Myko® - Lever S28

<b>Length</b>	128mm
<b>Projection</b>	60mm
<b>Finger Clearance</b>	36mm

This lever has an asymmetrical design and therefore must be handed.

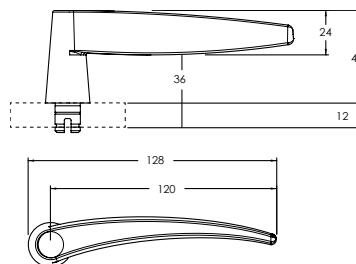

# Ovation® Series Door Handles

## Lever S55

**Length** 124mm

**Projection** 62.5mm

**Finger Clearance** 40.3mm

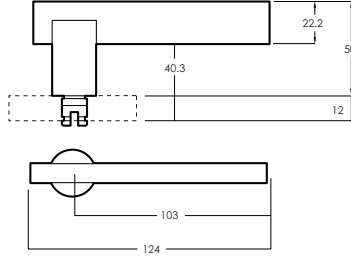

## Lever 95

**Length** 136mm

**Projection** 72mm

**Finger Clearance** 53mm

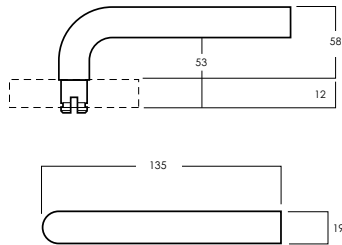

# Ovation® Series Door Escutcheons

## Oval Cylinder Escutcheon

**Part Number** 3226

Designed for use with Lockwood 3770 and 3570 Series Mortice Locks.

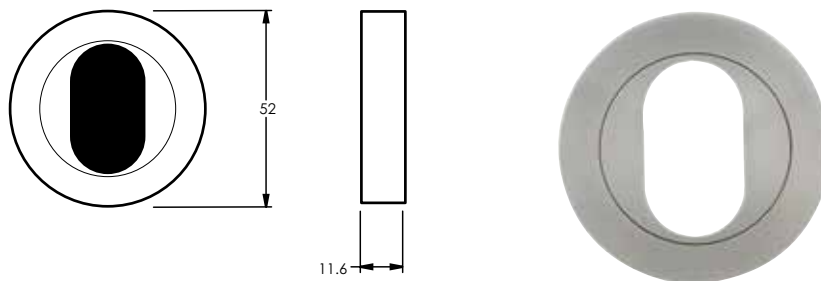

## Euro Profile Cylinder Escutcheon

**Part Number** 3226E

Designed for use with Union Mortice Locks.

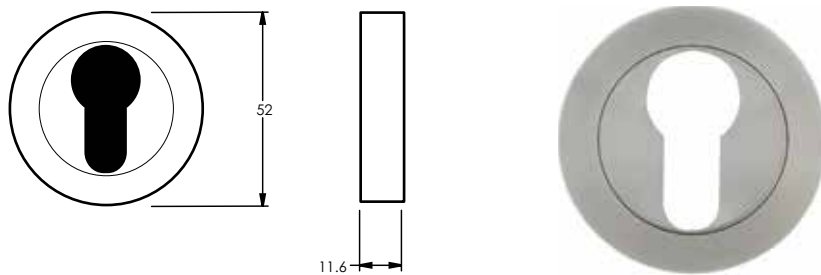

## Turnknob Escutcheon

**Part Number** 3227

Designed for use with Lockwood 3770 and 3570 Series Mortice Locks and 6260 Tubular Bolt.

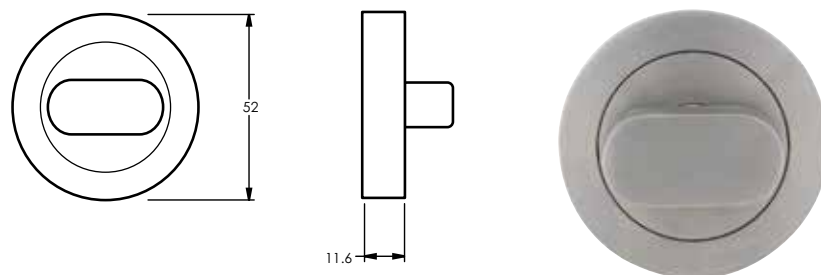

## Emergency Turn Escutcheon

**Part Number** 3228

Designed for use with Lockwood 3770 and 3570 Series Mortice Locks and 6260 Tubular Bolt.

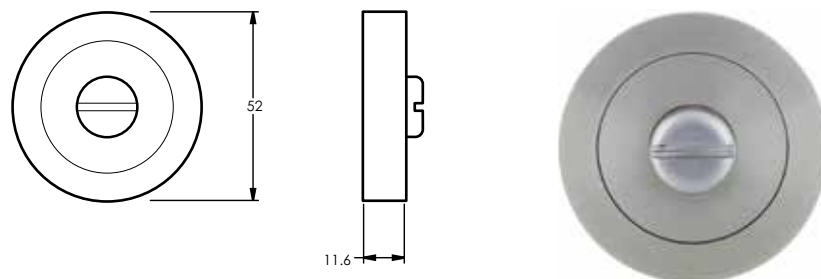

# Ovation® Series Door Accessories

## Privacy Adaptor 3290

**Part Number** 3290

The 3290 Privacy Adaptor has a patented built in clutching mechanism which allows the engaged mode to be overridden by use of specified force applied in a single downward action on the lever.

When safety, privacy and convenience is required the 3290 Privacy Adaptor is the perfect solution.

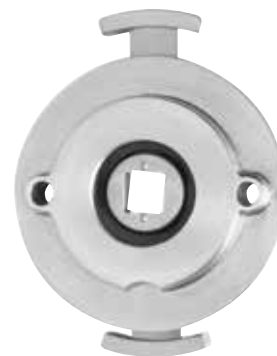
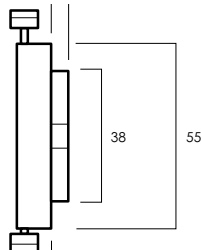
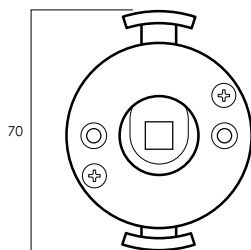

# Ovation® Series Ordering Procedure

Sample part number 3220/3221/H08SS is made up of several sections.  
Choose your product by selecting an option from each section.

## Half Set

For example:

Exterior Rose	Lever Type	Handing	Finish
3220	H08	L	SS

**Note:** Choose one rose only, exterior or interior and required lever

## Full Set

Escutcheon Type	Interior Rose	Lever Type	Handing	Finish
3220	3221	H08	-	SS

Escutcheon Type	
Exterior Rose	3220
Exterior Fixed Rose	3224

Interior Rose Type	
Interior Rose	3221
Interior Fixed Rose	3225

Levers	
Cuji®	H08
Tulu®	H11
Nusa®	H20
Dema®	H54
Aria®	S27
Myko®	28
Lever S55	S55
Lever 95	95

Handing	
Left Hand	L
Right Hand	R
NB: Omit if non-handed	

Finish	
Satin Stainless Steel	SS

AS1428.1 Compliant Levers	
Lever S23	S23
Lever 96	96

Handed Levers	
Myko®	S28

Sample part number 3226SS is made up of several sections.  
Choose your product by selecting an option from each section.

## Escutcheons

Escutcheon Type	Finish
3226	SS

Escutcheon Rose Type	
Oval Cylinder Escutcheon	3226
Euro Profile Cylinder Escutcheon	3226E
Turnknob Escutcheon	3227
Emergency Turn Escutcheon	3228
Privacy Adaptor	3290

Finish	
Satin Stainless Steel	SS

# Velocity® Series Large Rose Door Furniture



The Velocity Series is a stylish range of door furniture suitable for use in residential dwellings.

Designed to suit common door preparations in the Australian market, Velocity is ideal for both new and retrofit applications.

#### Retrofitable

Fits majority of doors with 54mm hole.

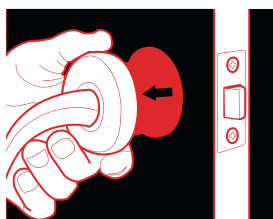

#### 1 Align 2 Twist 3 Tighten



#### Features and Specifications

- All fixings are concealed beneath a removable rose trim providing a crisp and clean presentation desired by the discerning home owner
- Simple twist and tighten fixing method and lever set pre-assembly allows for super easy and super fast installation
- Available in a choice of six lever designs and three finishes
- The rose fits 50mm or 54mm diameter holes making it suitable for retrofit and common door preparations
- Designed in Australia for the specific needs of the Australian market

#### Product Details

**Rose Dimensions** 63mm by 12.5mm.

**Materials** All Velocity levers and roses are made from solid zinc die-cast with steel rose trims.

**Latches** Passage sets are available both with and without a 60mm backset tubular latch. Privacy sets are supplied with a 60mm backset privacy latch which includes an activating pin for the inside of the door and an external emergency release function. The latch is automatically released when the internal handle is operated and is easily adapted for both open in and open out applications. All latches are supplied with industry standard "D" strikes.

**Door Thickness** 32mm to 45mm hinged doors

**Finishes** Satin Chrome Brushed (SC)  
Satin Chrome Pearl (SP)  
Chrome Plate (CP)

#### Standards and Compliance

**D1** Tested to AS4145.2 2008 for Durability passing D5 - 100,000 cycles.



Tested to AS4145.2 2008 for Neutral Salt Spray with SC, CP & SP finishes passing C5 Moderate Corrosion Resistance - 96 hours.

Not suited to coastal applications

# Velocity® Series Large Rose Door Handles

## Summit® – Lever 1

<b>Length</b>	122mm
<b>Projection</b>	56.5mm
<b>Finger Clearance</b>	34.5mm

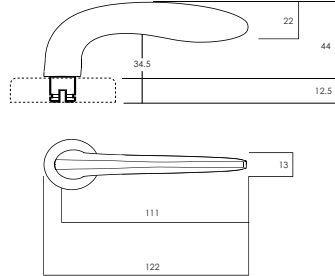

## Spire® – Lever 2

<b>Length</b>	124mm
<b>Projection</b>	57.5mm
<b>Finger Clearance</b>	44.5mm

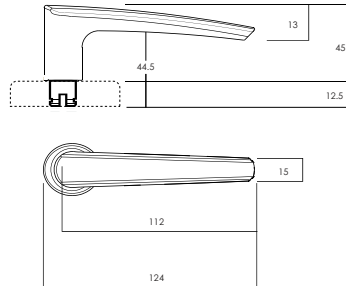

## Element™ – Lever 3

<b>Length</b>	122mm
<b>Projection</b>	54.5mm
<b>Finger Clearance</b>	47.5mm

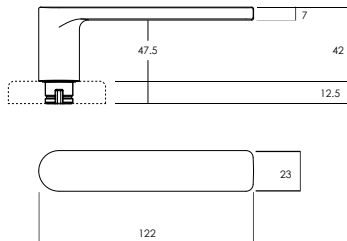

## Glide™ – Lever 4

<b>Length</b>	121mm
<b>Projection</b>	56.5mm
<b>Finger Clearance</b>	33.5mm

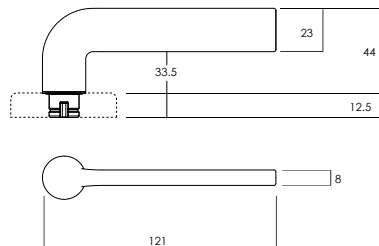

# Velocity® Series Large Rose Door Handles

## Hakea® - Lever 28

<b>Length</b>	121mm
<b>Projection</b>	63mm
<b>Finger Clearance</b>	43mm

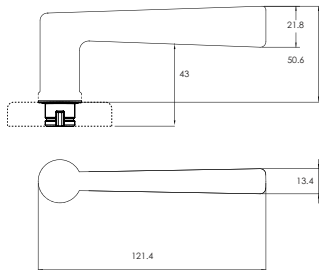

## Saltbush® - Lever 34

<b>Length</b>	120mm
<b>Projection</b>	64mm
<b>Finger Clearance</b>	43.5mm

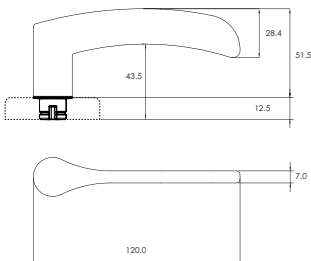



# Velocity® Series Large Rose Ordering Procedure

## Ordering Procedure

Sample part number VEL1/L1/SC is made up of several sections. Choose your product by selecting an option from each section.

## Velocity® 63mm Series

Exterior Rose	Function	Lever Type	Latch	Finish	Packaging
VEL	1	L1		SC	

Rose Type	Levers	Latch	Finish	Packaging
63mm Round Rose VEL	Summit® L1	No latch (Passage only) NL	Satin Chrome Brushed SC	Trade -
	Spire® L2		Satin Chrome Pearl SP	Display DP
	Element™ L3		Chrome Plate CP	
	Glide™ L4			
	Hakea® 28			
	Saltbush® 34			

Function	
Passage	1
Privacy	2
Dummy Half	3

# Velocity® Series Small Rose Door Handles



The Velocity 55mm Series is a stylish range of door furniture suitable for both residential and semi commercial applications. Designed primarily for new installation on timber doors, the range incorporates functionality for use with Mortice Locks in addition to Passage, Privacy and Dummy Levers.

## Installation

Suits door preparations up to 45mm.

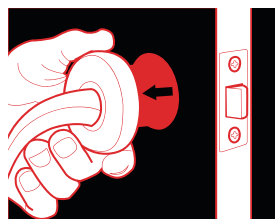

1 **Align**    2 **Twist**    3 **Tighten**



## Features and Specifications

- All fixings are concealed beneath a removable rose trim providing an aesthetically appealing installation.
- Simple twist and tighten fixing method and pre-assembled lever sets allow for super easy and fast installation.
- Lever range includes two AS1428.1 compliant levers and six designer levers.
- Accessories include AS1428.1 compliant turn, standard turn and privacy indicating emergency turns.
- The 55mm rose suits up to 45mm door preparations commonly used with mortice locks or latches.
- Designed in Australia for the specific needs of the Australian market.

## Product Details

<b>Rose Dimensions</b>	55mm by 12.5mm - Round Rose 58mm by 12.5mm - Square Rose
<b>Materials</b>	All Velocity 55mm levers and roses are made from solid zinc die-cast.
<b>Latches</b>	Passage sets are available with a 60mm backset tubular latch. Privacy sets are supplied with a 60mm backset privacy latch which includes a locking pin for the inside of the door and an external emergency release function. The latch is automatically released when the internal handle is operated and is easily adapted for both open in and open out applications. All latches are supplied with industry standard "D" strikes.
<b>Door Thickness</b>	32mm to 45mm hinged doors
<b>Finishes</b>	Satin Chrome Brushed (SC) Chrome Plate (CP) Satin Pearl (SP) Display Pack Range Only

## Standards and Compliance



Successfully tested up to 2 hours on fire door assemblies in accordance with the Australian Standard AS1905.1 2005 - Part 1: Fire Resistant Doorsets

**D8**

Tested to AS4145.2 2008 for Durability passing D8 - 500,000 cycles.



Tested to AS4145.2 2008 for Neutral Salt Spray with SC, CP & SP finishes passing C5 Moderate Corrosion Resistance - 96 hours



AS1428.1 Compliance.  
The range includes AS1428.1 compliant levers and turns as shown.

# Velocity® Series Small Rose Door Handles

## AS1428.1 Compliant Levers

### Accession® - Lever 5

**Length** 121mm

**Projection** 56.5mm

**Finger Clearance** 38.4mm



Disabled Accessible  
AS1428.1

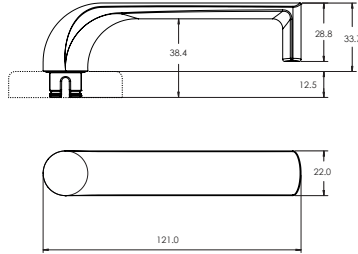

### Dianella™ - Lever 8

**Length** 121mm

**Projection** 51mm

**Finger Clearance** 38mm



Disabled Accessible  
AS1428.1

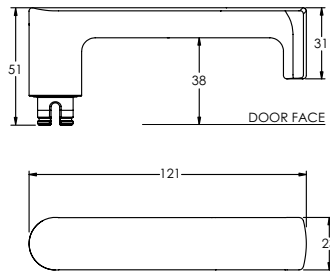

### Gidgee® - Lever 37

**Length** 120mm

**Projection** 64mm

**Finger Clearance** 38.5mm



Disabled Accessible  
AS1428.1

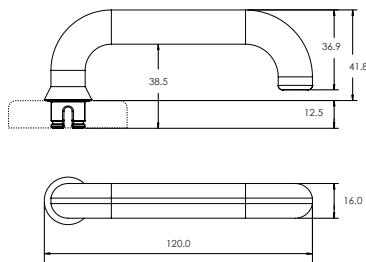

## Standard Levers

### Element™ - Lever 3

**Length** 122mm

**Projection** 54.5mm

**Finger Clearance** 47.5mm

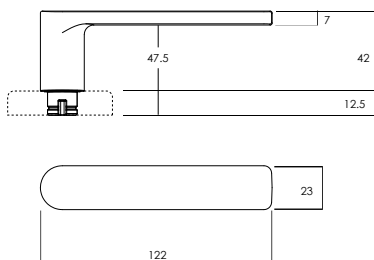

# Velocity® Series Small Rose Door Handles

## Standard Levers

### Hakea® - Lever 28

<b>Length</b>	121mm
<b>Projection</b>	63mm
<b>Finger Clearance</b>	43mm

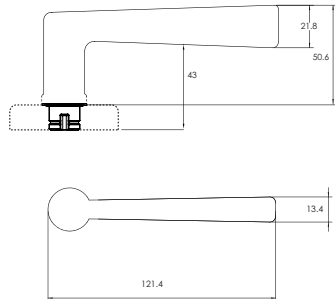

### Acacia® - Lever 29A

<b>Length</b>	120mm
<b>Projection</b>	64mm
<b>Finger Clearance</b>	41.5mm

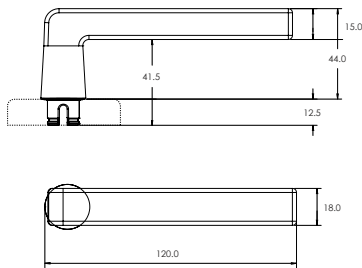

### Saltbush® - Lever 34

<b>Length</b>	120mm
<b>Projection</b>	64mm
<b>Finger Clearance</b>	43.5mm

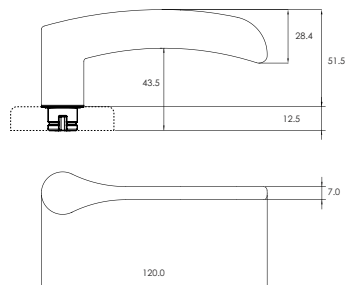

# Velocity® Series Small Rose Door Handles

## Euro Cylinder Escutcheon

<b>Part Number</b>	VSR5
<b>Height</b>	55mm
<b>Depth</b>	12.5mm

**Supplied with**  
2x Wood Screws

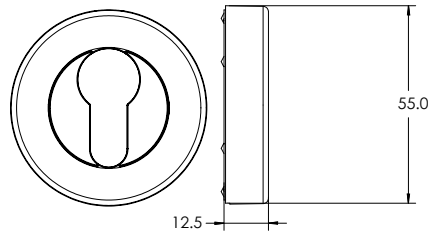

## Oval Cylinder Escutcheon

<b>Part Number</b>	VSR6
<b>Height</b>	55mm
<b>Depth</b>	12.5mm

**Supplied with**  
2x Wood Screws

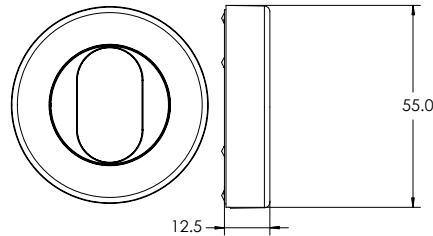

## Standard Turnknob

<b>Part Number</b>	VSR7
<b>Height</b>	55mm
<b>Depth</b>	12.5mm
<b>Handing</b>	Not required

**Supplied with**  
2x Wood Screws  
1x Short Tail Bar  
1x Medium Tail Bar  
1x Tail Bar Spring  
1x Instructions (1220-321)

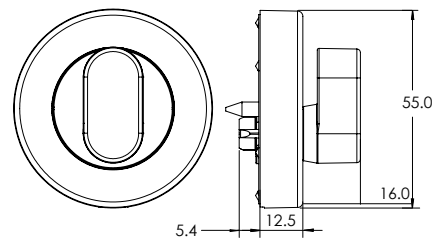

## Privacy Indicating Emergency Turn

<b>Part Number</b>	VSR8
<b>Height</b>	55mm
<b>Depth</b>	12.5mm

**Supplied with**  
2x Wood Screws  
1x Emergency Tail Bar  
1x Instructions (1220-321)

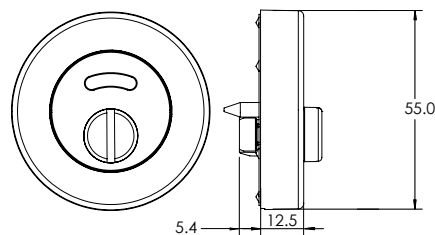

# Velocity® Series Small Round Rose Accessories

## Disabled Accessible Turnknob

<b>Part Number</b>	VSR9
<b>Height</b>	55mm
<b>Depth</b>	12.5mm
<b>Turn Snib Length</b>	52mm
<b>Handing</b>	Site handable

### Supplied with

- 2x Wood Screws
- 1x Tail Bar (short)
- 1x Tail Bar (medium)
- 1x Tail Bar Spring
- 1x Instructions (1220-321)

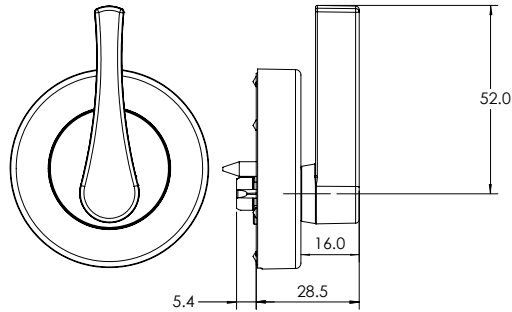

## Round Rose Passage Trim

<b>Part Number</b>	VSR1-TRIM
<b>Height</b>	55mm
<b>Depth</b>	12.5mm
<b>Quantity</b>	Pack of 2

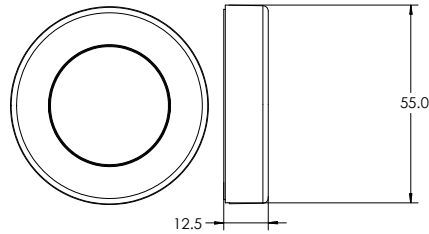

## Round Rose Privacy Trim

<b>Part Number</b>	VSR2-TRIM
<b>Height</b>	55mm
<b>Depth</b>	12.5mm
<b>Quantity</b>	Pack of 2

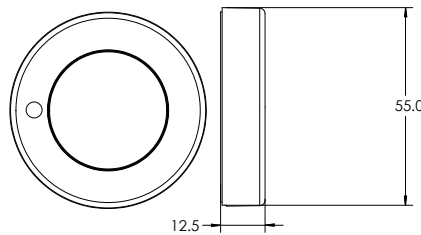

# Velocity® Series Small Square Rose Accessories

## Euro Cylinder Escutcheon

<b>Part Number</b>	VSS5
<b>Height</b>	58mm
<b>Depth</b>	12.5mm

**Supplied with**  
2x Wood Screws

**Note:** Please ensure clearance between lever trim and escutcheons when used with European Mortice Locks.

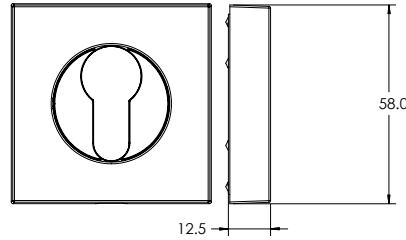

## Oval Cylinder Escutcheon

<b>Part Number</b>	VSS6
<b>Height</b>	58mm
<b>Depth</b>	12.5mm

**Supplied with**  
2x Wood Screws

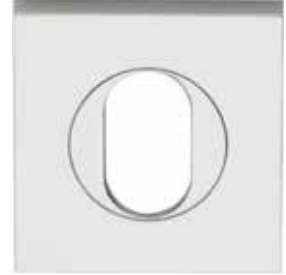
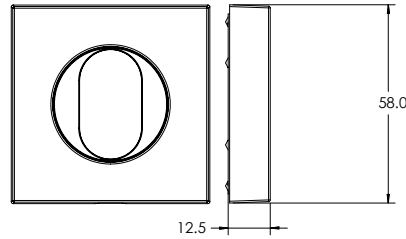

## Standard Turn Snib

<b>Part Number</b>	VSS7
<b>Height</b>	58mm
<b>Depth</b>	12.5mm
<b>Handing</b>	Not required

**Supplied with**  
2x Wood Screws  
1x Short Tail Bar  
1x Medium Tail Bar  
1x Tail Bar Spring  
1x Instructions (1220-321)

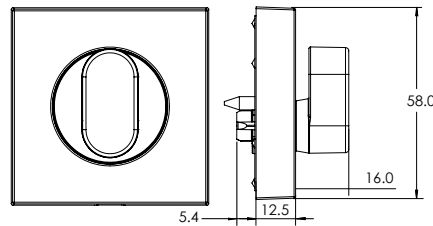

## Emergency Indicating Turn

<b>Part Number</b>	VSS8
<b>Height</b>	58mm
<b>Depth</b>	12.5mm
<b>Handing</b>	Not required

**Supplied with**  
2x Wood Screws  
1x Emergency Tail Bar  
1x Instructions (1220-321)

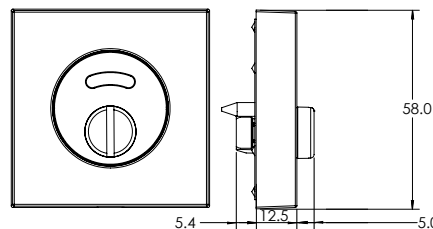

# Velocity® Series Small Square Rose Accessories

## Disabled Accessible Turn Snib

<b>Part Number</b>	VSS9
<b>Height</b>	58mm
<b>Depth</b>	12.5mm
<b>Turn Snib Length</b>	52mm
<b>Handing</b>	Site handable

### Supplied with

- 2x Wood Screws
- 1x Tail Bar (short)
- 1x Tail Bar (medium)
- 1x Tail Bar Spring
- 1x Instructions (1220-321)

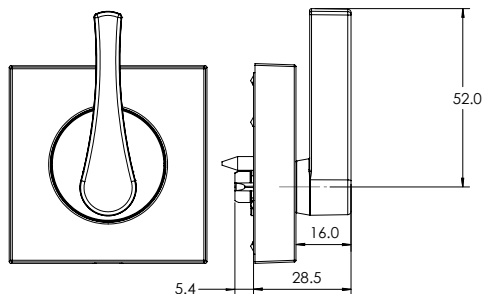

## Square Rose Passage Trim

<b>Part Number</b>	VSS1-TRIM
<b>Height</b>	58mm
<b>Depth</b>	12.5mm
<b>Quantity</b>	Pack of 2

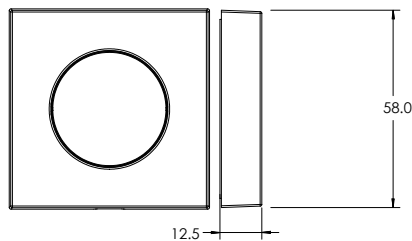

## Square Rose Privacy Trim

<b>Part Number</b>	VSS2-TRIM
<b>Height</b>	58mm
<b>Depth</b>	12.5mm
<b>Quantity</b>	Pack of 2

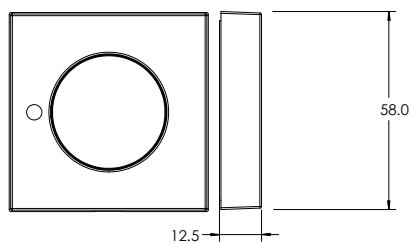



# Velocity® Series Rose Door Handles

Sample part number VSR1/L3SC is made up of several sections. Choose your product by selecting an option from each section.

## Velocity® Small Rose Series - Trade Pack Range

Exterior Rose	Function	Lever Types	Finish
VSR	1	L3	SC

Rose Type	Function	Levers	Finish	Packaging
Velocity 55mm Round Rose <span style="float: right;">VSR</span>	Mortice 0	Summit® L1	Satin Chrome Brushed SC	Trade Pack
Velocity 58mm Square Rose <span style="float: right;">VSS</span>	Passage 1	Element™ L3	Chrome Plate CP	
	Privacy 2	Glide™ L4		
	Dummy Half 3	Hakea® 28		
	Euro Escutcheon 5	Acacia® 29A		
	Oval Escutcheon 6	Saltbush® 34		
	Standard Turnknob 7	<b>AS1428.1 Compliant Levers</b>		
	Privacy Indicating Emergency Turn 8	Accession® L5		
	Disabled Accessible Turnknob 9	Dianella™ L8		
		Gidgee® 37		

## Velocity® Small Rose Series - Display Pack Range

Rose Type	Function	Lever Types	Finish	Packaging
VSR	1	L3	SC	DP

Rose Type	Function	Levers	Finish	Packaging
Velocity 55mm Round Rose <span style="float: right;">VSR</span>	Passage 1	Summit® L1	Satin Chrome Pearl SP	Display DP
	Privacy 2	Spire® L2	Chrome Plate CP	
		Element™ L3	Satin Chrome Brushed SC	
		Glide™ L4		

### Square Rose Ordering Procedure

Function	SC Finish	CP Finish	SP Finish
Mortice Lever Set			
Passage Lever Set	VSS1-TRIMSC	VSS1-TRIMCP	VSS1-TRIMSP
Dummy Half Set			
Privacy Lever Set	VSS2-TRIMSC	VSS2-TRIMCP	VSS2-TRIMSP

Square Rose Lever Sets are ordered in the same manner as Round Rose Lever Sets above with the addition of a Square Rose Trim Pack. For example a Mortice Lever Set, Lever 5 in Satin Chrome will require both VSR0/L5SC and VSS1-TRIMSC.



**ASSA ABLOY**

**Lockwood** is the leading brand in the Australian locking industry. With an established reputation for high quality products, this iconic brand provides a wide range of locking solutions to residential housing, commercial, semi-commercial, building and industrial application markets. Lockwood is supported by an extensive distribution and after-sales support network. Our customers include retailers, architects, trade and industrial personnel, locksmiths and security dealers.

**ASSA ABLOY** is the global leader in door opening solutions, dedicated to satisfying end-user needs for security, safety and convenience.

**ASSA ABLOY** is represented in all major regions, in both mature and emerging markets, with leading positions in Australia, Europe and North America.

**25YEAR  
MECHANICAL  
WARRANTY**

### **The Lockwood 25 Year Mechanical Warranty**

Our belief that we manufacture the finest premium products available in today's market place is backed by the Lockwood 25 Year Mechanical Warranty, ensuring that Lockwood continues to keep Australians safe by delivering security and peace of mind.

For warranty terms and conditions, please visit [www.lockweb.com.au](http://www.lockweb.com.au) or call **1300WARRANTY**

**ASSA ABLOY Australia Pty Ltd**  
235 Huntingdale Road  
Oakleigh, Victoria, 3166  
Australia

**1300 LOCK UP (1300 562 587)**  
[lockweb.com.au](http://lockweb.com.au)

**ASSA ABLOY New Zealand Ltd**  
6 Armstrong Road  
Albany, Auckland, 0632  
New Zealand

[info.nz@assaabloy.com](mailto:info.nz@assaabloy.com)  
Telephone +64 9415 7111  
[assaabloy.co.nz](http://assaabloy.co.nz)

#### **Disclaimer**

Whilst every effort has been made to ensure that the information (including product images and drawings) contained in this brochure is accurate at the time of publication, ASSA ABLOY Australia Pty Limited ("ASSA ABLOY") recommends that you consult ASSA ABLOY or its agents prior to placing an order to ascertain current information on specific products, as ASSA ABLOY reserves the right to make changes without notice. ASSA ABLOY will not be liable for any injury, loss or damage whatsoever, arising from any errors or omissions in the information contained in the brochure or arising from the use or application of the information contained herein. © 2017 copyright by ASSA ABLOY All rights reserved

